



National Research
Council Canada

Conseil national de
recherches Canada

NRC-CMRC

Sound Transmission Through Gypsum Board Walls: Sound Transmission Results

By J.D. Quirt, A.C.C. Warnock, J.A. Birta

Internal Report IRC-IR-693

October 1995

This project was jointly funded by:

Canada Mortgage and Housing Corporation
Canadian Sheet Steel Building Institute
Cellulose Insulation Manufacturers Association of Canada
Forintek Canada
Gypsum Manufacturers of Canada
National Research Council Canada
Owens-Corning Fiberglas Canada Inc.
Roxul Inc.

EXECUTIVE SUMMARY

The IRC Acoustics Laboratory has completed the measurement phase of a study of sound transmission through gypsum board walls.

The project was supported by a consortium including Canada Mortgage and Housing Corporation (CMHC), Canadian Sheet Steel Building Institute (CSSBI), Cellulose Insulation Manufacturers Association of Canada (CIMAC), Forintek Canada (FORINTEK), Gypsum Manufacturers of Canada (GMC), the Institute for Research in Construction of the National Research Council Canada (IRC/NRCC), Owens Corning Fiberglas Canada Inc. (OCFCI), and Roxul Inc. (ROXUL). A closely related study of fire resistance of gypsum board wall assemblies is also underway.

The study was needed because building products and test methods have changed, so old tests and estimates are potentially misleading. Further, many of the older published results do not clearly identify relevant construction details such as screw spacing, or do not match normal practice for fire resistance or other concerns.

This report presents the sound transmission class (STC) data for a large series of walls constructed with industry-standard details using a carefully characterized set of materials. Although some of the specimens were chosen by individual clients to demonstrate performance of specific products, these were combined with a structured series established collectively by the consortium.

The combined set of over 250 specimens provide the basis for systematic evaluation of sound transmission through gypsum board wall systems, as a basis for prediction methods and development of improved constructions. More immediately, they provide the authoritative assembly of STC data needed by builders and regulators to select constructions suitable for party walls in multi-family dwellings.

TABLE OF CONTENTS

Introduction	3
Measurement of Sound Transmission	
Measurement Process	4
Precision and Reproducibility	5
Experiment Design	8
Specimen Description	
Specimen Installation Details	9
Characteristics of Materials	11
Tables of Sound Transmission Data	
Single Row of Wood Studs	13
Staggered Wood Studs	19
Double Wood Studs	23
Non-loadbearing Steel Studs	26
Loadbearing Steel Studs	36
Appendix A: Specimen Details	39
Appendix B: Material Properties	63
Appendix C: Preliminary Systematic Study	73

INTRODUCTION

The IRC Acoustics Laboratory has completed the measurement phase of a study of sound transmission through gypsum board walls.

The project was supported by a consortium including Canada Mortgage and Housing Corporation (CMHC), Canadian Sheet Steel Building Institute (CSSBI), Cellulose Insulation Manufacturers Association of Canada (CIMAC), Forintek Canada (FORINTEK), Gypsum Manufacturers of Canada (GMC), the Institute for Research in Construction of the National Research Council Canada (IRC/NRCC), Owens Corning Fiberglas Canada Inc. (OCFCI), and Roxul Inc.(ROXUL). A closely related study of fire resistance of gypsum board wall assemblies is also underway.

This report presents the sound transmission class (STC) data for a large series of walls constructed with industry-standard details, and a carefully characterized set of materials. The study responds to serious industry problems:

- An authoritative assembly of STC data is needed for builders and regulators: The increased sound insulation required in the 1990 National Building Code has highlighted the shortage of reliable acoustical data for walls with STC over 50.
- Some published STC data are obsolete or suspect: Building products and test methods have changed, so old tests and estimates are potentially misleading.
- Most published data do not clearly identify relevant construction details such as screw spacing, or do not match normal practice for fire resistance or other concerns.
- Problems with inter-laboratory reproducibility and variation in specimen construction details inhibit systematic comparison of the sound insulation of walls tested at different laboratories over the years. By providing a large, carefully controlled set of data to establish systematic trends, this study provides the basis for developing improved constructions.
- Most published sound transmission results do not include the low frequencies that dominate noise problems in modern buildings. Although this report does not resolve that need, the study has provided the necessary data, which will be presented in subsequent IRC publications.

Although some of the specimens were chosen by individual clients to demonstrate performance of specific products, these were combined with a structured series established collectively by the consortium. The combined set of over 250 specimens provide the basis for a broad general evaluation of sound transmission through gypsum board wall systems.

These are further supplemented by the preceding systematic study of sound transmission changes due to specific variables, whose results were summarized in Report A-1012.1 and in subsequent technical publications. A revised version of Report A-1012.1 is presented in Appendix C. Those specimens were chosen to examine the parametric dependence of sound transmission on material properties and construction details including: density and airflow resistance of cavity absorption, amount and location of absorptive material, spacing and type of framing, and how the gypsum board is attached to the framing. Other factors such as gypsum board properties and the effect of insulation stiffness were omitted from the systematic study because the main series (reported here) would provide more comprehensive evaluation.

Some additional research is planned, to clarify trends suggested by the data reported here. It is anticipated that the assembled database will both meet regulatory needs and provide the basis for validation and refinement of a prediction model.

Subsequent IRC/NRCC reports will analyze trends in the sound transmission results, present full tabulation of the data, and incorporate these results with those of the companion study of fire resistance.

MEASUREMENT PROCESS

The acoustical measurements were made in the suite of reverberation chambers in building M-27 of IRC/NRCC. Wall specimens are mounted in a removable test frame between two chambers, without rigid contact to either reverberation chamber. The wall test opening measures 3.05 m x 2.44 m. The volume of the source room is 65 m³. The volume of the adjacent receiving room is 250 m³. Both reverberation chambers are supported on spring vibration isolators. In addition to fixed diffuser panels in both rooms, the large room also has a rotating diffuser panel. Test signals are supplied to each room by four loudspeakers with independent sound sources. Each room has a calibrated condenser microphone (B&K Type 4166, 12.5 mm diameter) positioned by a computer-controlled robot arm.

Tests are conducted in accordance with the requirements of ASTM E90-1990, Standard Method for Laboratory Measurement of Airborne Sound Transmission Loss of Building Partitions, and of ISO 140/III 1978(E), Laboratory Measurement of Airborne Sound Insulation of Building Elements. Measurements are controlled by a desktop PC-type computer interfaced to a Norwegian Electronics type 830 real time analyzer. Under computer control, the microphones are moved to nine positions to sample the sound field in each chamber. Sound pressure levels are measured at each of the nine microphone positions, and combined to get the average sound pressure level in each room. Five sound decays are averaged to get the reverberation time at each microphone position in the receiving room; these times are then averaged to get mean reverberation times for the room. The sound pressure level and reverberation time measurements are made for all standard one-third-octave-bands from 50 Hz to 6.3 kHz. These data are then used to calculate Sound Transmission Loss for each frequency band as specified in ASTM E90.

The Sound Transmission Class was determined in accordance with ASTM Standard Classification E413. The Weighted Sound Reduction Index was determined in accordance with ISO 717, Rating of Sound Insulation in Buildings and of Building Elements, Part 1: Airborne Sound Insulation in Buildings and of Interior Building Elements. The Sound Transmission Class (STC) and Weighted Sound Reduction Index (R_w) are single-figure ratings of the acoustical performance for a partition element under typical conditions involving office or dwelling separation. The higher the value of either rating, the better the wall performance. These ratings are intended to correlate with subjective impressions of the sound insulation provided against the sounds of speech, radio, television, office machines and similar sources of noise characteristic of offices and dwellings. In applications involving noise spectra that differ markedly from those referred to above (for example, heavy machinery, power transformers, aircraft noise, motor vehicle noise), the STC and R_w are of limited use.

PRECISION AND REPRODUCIBILITY

Acoustical measurement in rooms involves sampling non-uniform sound fields, and as such has associated with it a degree of uncertainty. By correctly performing a number of measurements to determine a spatial average, the uncertainties can be reduced. Upper and lower limits can then be assigned to the probable error in the measurement. These precision limits can be described in terms of the concepts of *repeatability* and *reproducibility*.

Repeatability is defined as the closeness of agreement between independent results obtained with the identical test specimen in the same laboratory with the same equipment and test method by the same operator within a short time period.

Reproducibility is defined as the closeness of agreement between results obtained on nominally identical test specimens with the same test method in different laboratories. Obviously this includes the deviations due to systematic differences between facilities and equipment, any variations in implementation of the test procedures, and also any uncontrolled differences in the specimen and its installation. The reproducibility is a characteristic of the test method, which must be determined by an inter-laboratory comparison study. For ISO 140, reproducibility has been shown to range from 3 dB at mid-frequencies to 7 dB at low frequencies. Values should agree within this range 19 times out of 20, and will agree more closely most of the time. It is because of this large uncertainty that systematic studies in one laboratory (like that reported here) are needed for clear comparisons.

Variability expected among measured results for nominally equivalent specimens in this study should be between these extremes of reproducibility and repeatability, because all measurements were made with a consistent test method using the same facility and equipment

A working estimate of this was generated by repeated measurements with the same wall specimen over a period of two days, as shown in Figure 1. Clearly, the results in Fig. 1 are all very similar. The repeatability estimates for each frequency band, calculated as specified in ISO 140, are given beside the graph in Fig. 1. The mean of these values (0.4 dB) is a reasonable working estimate for repeatability. A pair of results obtained under repeatability conditions are expected to agree within this limit, 19 times out of 20. The variation of 1 in the STC value (it was either 47 or 48 for all these tests) is consistent with this estimate.

If observed differences between results in our laboratory exceed this repeatability estimate, the change in sound transmission can be attributed to a change in the specimen.

Fig. 1: Results of sound transmission measurements with one wall specimen, to evaluate repeatability over a two-day period. (Solid curve is mean, dotted curves are minimum and maximum.)

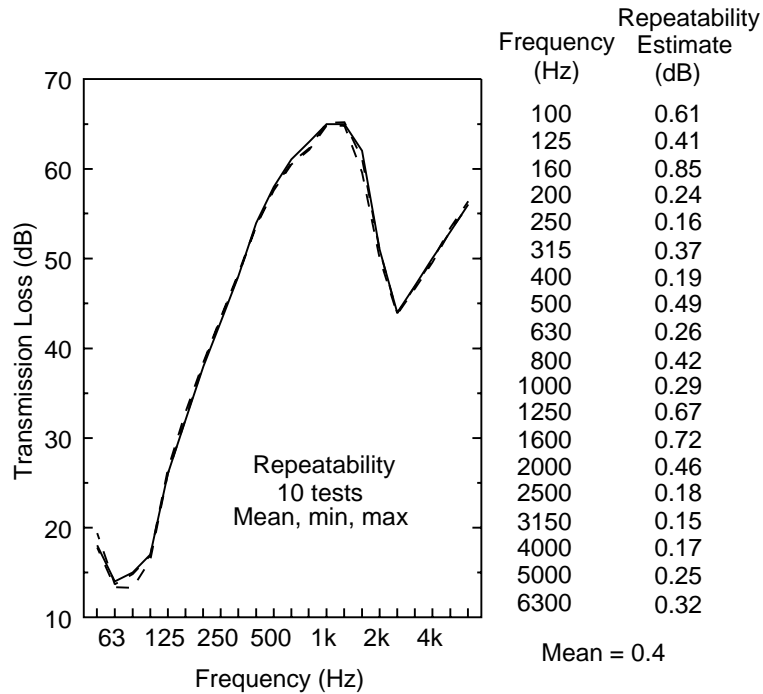

As discussed in the following section, the experiment design was structured to permit the most precise comparisons feasible. However, it should be recognized that results from another laboratory (or even results from this laboratory with a nominally equivalent specimen at another time) would be unlikely to agree within this precision estimate. Hence, the changes observed between nominally identical specimens were sometimes 2 or 3 times greater than the repeatability estimate in Fig. 1, presumably due to differences in how the specimen was assembled.

The STC results were particularly sensitive to sound transmission in the 125 Hz band, and small changes in transmission for that one band frequently altered the STC. The ISO rating (R_w) was also strongly affected by the low frequency sound transmission; it was often controlled by the 100 Hz to 160 Hz bands but was not so affected by minor fluctuations in individual bands. However, for gypsum board walls both overall ratings tend to be controlled by sound transmission performance at low frequencies.

Allowing for these factors, a difference of 1 between STC ratings for two specimens should not be considered significant. A change of 2 in STC (or consistent change of 1 between two groups of specimens) indicates a real difference.

EXPERIMENT DESIGN

To minimize the effect of construction variations among specimens, the series used “small change comparisons” as much as possible. This approach was based on constructing framing and then using that framing for a group of tests, to permit comparisons with a sequence of small changes from specimen to specimen. Each group of specimens included a case with 15.9 mm Type X gypsum board and Type (G1) glass fiber batts; these could be compared to ensure consistency among groups. With this approach, the precision could be qualitatively characterized for several types of comparisons:

- 1) **Screw pattern changes** involved removing and/or adding some screws, such as the comparisons of different attachment to the top plate or track discussed later in the sub-section on gypsum board attachment. For some modifications, the sound transmission was altered by less than 0.2 dB in all bands. For others, there were systematic changes of several decibels in most frequency bands. However, in all these cases the changes were repeatable within the repeatability estimate, and changes varied smoothly between adjacent frequency bands with fluctuations less than the repeatability estimate. Hence systematic changes (or the absence of changes) could be clearly observed .
- 2) **Gypsum board layer changes** to add or remove a second layer of gypsum board on either face of the specimen also showed clear trends, with fluctuations in individual frequency bands about the same as the repeatability estimate.
- 3) **Insulation changes** required removal of gypsum board from one face, exchange of the insulation and installation of new sheets of the same type of gypsum board. Such changes introduced variability up to twice the repeatability estimate.
- 4) **Complete reconstruction** introduced even larger variation, especially for frequency bands from 500 Hz to 2 kHz. Even in these cases, the change in STC values was usually less than 2.

Comparison of nominally identical specimens was used as an indicator of construction consistency among groups of specimens. In cases where STC results for these reference specimens differed by 2 or more, groups of tests were repeated and the anomalous set of results were discarded; in each such case there was supplementary evidence suggesting the possibility of installation errors. Good consistency (STC change of 0 or 1) was observed in most such comparisons.

SPECIMEN INSTALLATION DETAILS

Metric Dimensions: This report uses metric dimensions only. The dimensions are converted to precise metric sizes where that conforms to normal industry practice, such as thickness of gypsum board or dimensions of studs. Some dimensions such as spacing between studs (which was previously specified as 16 or 24 in.) have been converted to approximate equivalents (400 and 600 mm respectively) to match normal practice, as in the National Building Code of Canada.

Specimen size: Wall specimens were mounted in removable test frames whose opening measures 3.05 m x 2.44 m. The faces of these frames are lined with wood, and the specimen framing was screwed to these surfaces. One frame has this lining split and resiliently mounted; this was used for double stud specimens. Coupling between the test frame and the sound field in the chambers was reduced by installing shields over the exposed parts of the test frame. The shields mask about 2 cm at the perimeter of the specimens; the actual exposed specimen area was used for calculation of Sound Transmission Loss.

For specimens with studs spaced 400 mm o.c. apart, a smaller (200 mm) inter-stud cavity occurs at one side of the specimen. This was masked off, because tests at IRC/NRCC and elsewhere have shown slightly different Sound Transmission Loss when these small sub-panels are included as part of the specimen. Hence, specimens with studs at 400 mm o.c. had an exposed width of approximately 2.8 m (seven inter-stud cavities).

Gypsum Board Attachment: The preceding systematic study (Report A1012.1) showed significant dependence of the sound transmission on fastener spacing and the type of framing. To ensure results were representative of practical walls, the specimens reported here were constructed with screw type and placement conforming to the pertinent requirements of the National Building Code of Canada and the applicable Canadian standard CAN/CSA-A82.31-M91 "Gypsum Board Application". The same screw patterns are being used in the companion study of fire resistance. The screw placement for a given sheet of gypsum board depends on the type of framing, spacing of supporting framing, and which layer of gypsum board is involved. Attention was given to the location of joints, to ensure they were staggered as required. Diagrams showing screw patterns and joint locations for each case are given in Appendix A.

To minimize installation variability, standard gypsum board screws were used in all cases, and were installed (using an electric screw gun)

so heads were just below the surface of the gypsum board, but not breaking the surface paper.

As indicated above in the discussion of precision, the comparison strategy used to minimize and assess specimen construction variability required repeated use of each set of studs. Except in cases where gypsum board was attached to resilient channels (which could easily be replaced), only nine or fewer changes of screws were used on either side of a set of studs. The screw positions were shifted (by about 1 cm) from one case to the next to avoid previous screw holes. Testing without changes other than screw relocations showed negligible variations in sound transmission due to such changes.

The effect of some possible variants from standard installation were examined for specimens with 25 gauge (0.50 mm) steel framing. For fire resistance, the 1990 National Building Code requires that non-loadbearing (25-gauge or 26-gauge) steel studs not be screwed to the upper track; that is, installation should conform to pattern (b) in Figures A-19 to A-24. Careful comparisons were made, altering specimens among screw patterns (a) to (d) shown in those figures. The resulting effect on sound transmission was negligible. Changes among patterns (a) to (c) caused no change in STC. In case (d) with no screws in the top track, some specimens exhibited an increase of 1 in STC. Only the STC results for patterns (a) to (c) were listed; these may reasonably be used for walls with any of the screw patterns shown.

Omitting screws at the upper edge of the gypsum board is also recommended for simple wood stud and staggered wood stud walls where potential uplift by roof trusses is of concern. The sound transmission ratings presented in the tables are for the case with screws into the top plate. Omitting those screws consistently increased the Sound Transmission Loss at mid-frequencies, and increased the STC by 1 in most cases tested.

Finishing at Joints and Edges: In normal construction practice, joints and edges of gypsum board walls are finished with joint compound and tape. However, repeated sound transmission testing of several wall specimens while the joint compound was drying confirmed that walls finished in this manner require about two days curing before achieving stable sound transmission performance. Since a series of over 200 walls was planned, a more rapid joint finishing technique was clearly desirable. Comparisons for four trial specimens showed that caulking joints and covering them with metalized duct tape gave sound transmission performance at all frequencies within a fraction of a decibel of that for standard finish with joint compound; the STC was the

same in all cases. If the joints were simply taped, the STC values tended to be lower. If joints were filled with a plasticine-like compound (used by some acoustical testing laboratories to fill joints), high frequency sound transmission loss and STC values tended to be higher than those for the standard finish. Hence, the caulking and tape finish were used to seal joints for all specimens reported here.

CHARACTERISTICS OF MATERIALS

Properties of the materials are being characterized as fully as possible. The specific properties measured and/or recorded included:

- Dimensions and weight were recorded for every component (framing, insulation, gypsum board, etc.) of each wall specimen, together with any special features of the materials or installation.
- Stiffness of gypsum board was measured in the FORINTEK laboratories for many samples of the main types of gypsum board.
- Wood studs were conditioned in the FORINTEK laboratories at 50% relative humidity, to establish consistent moisture content. The water content was intended to be representative of that for wall assemblies several years after construction. Moisture for each wood stud was measured at FORINTEK, and subsequently checked in the IRC/NRCC laboratory during the testing with each wood frame assembly.
- Stiffness of wood studs was measured in the Forintek laboratories for each wood stud. Stiffness of steel studs and resilient furring channels are being measured at IRC/NRCC.
- Airflow resistivity for samples of each type of absorptive material was measured at IRC/NRCC according to ASTM method C522-87.

Tables of material properties are presented in Appendix B; some further details will accompany tabulation of the sound transmission results in 1/3-octave-bands, in later IRC/NRCC reports.

Most of the materials used in these assemblies are manufactured products with clearly defined dimensions and other properties. The exception to this rule is cellulose fiber, for which the base material has controlled properties, but the installation permits some variation, as it is blown into or sprayed into the wall cavities on site. This permits variation in density, which affects both air flow resistance and stiffness of the resulting cavity fill. The density was measured when each wall specimen with cellulose fiber was taken apart, and is presented in the

tables. However, the effect of changing density was not systematically evaluated.

Stiffness of absorptive material in the inter-stud cavities could become an issue if this material provides a path for vibration transmission from one face of the wall to the other, through contact with the gypsum board faces and/or the framing. In some cases, the low frequency sound transmission was decreased in a manner consistent with the expected effect of increased cavity stiffness. This was observed for specimens where the cavity was completely filled with a high density of cellulose fiber. Similar reduction in sound transmission at low frequencies was evident with very stiff mineral fiber material (such as Type M3 in Table SS-1) and with any cavity fill that had to be compressed significantly to attach the gypsum board. Qualitatively, the stiffer the absorptive material and the more it is compressed, the greater the effect on sound transmission.

Further work is planned to examine the dynamic stiffness of each type of absorptive material, and of steel studs and resilient channels. The results of this study strongly suggest that stiffness of the absorptive material or the framing can significantly alter the low frequency sound transmission, and hence the STC. There is no established standard method for measuring stiffness of such products or evaluating whether their stiffness is suitable, but the present work illustrates the effect on sound transmission, especially for the absorptive materials. Efforts will be made to establish a suitable evaluation protocol for these products.

In the meanwhile, this study provides a reasonable assessment of the performance of normally-assembled walls with typical materials.

Table WS-1: Wood studs at 400 mm o.c., with one or two layers gypsum board on each side

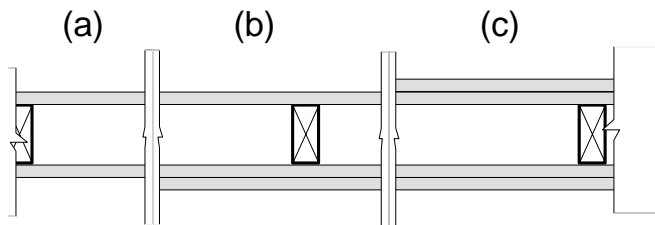

one or two layers of gypsum board
 38x89 mm wood studs at
 400 mm o.c., with absorptive
 material (as noted) in stud cavity
 one or two layers of gypsum board

a) One layer of gypsum board on each side:

Gypsum board	Absorptive Material	Test Number	STC	R _w
15.9 mm Type X (C)	mineral fibre (M1) 90 mm batt	TL-93-157	34	37
12.7 mm Type X (A)	mineral fibre (M1) 90 mm batt	TL-93-188	34	39
	cellulose (C2) 90 mm blown (54 kg/m ³)	TL-93-176	32	38
12.7 mm (B)	mineral fibre (M1) 90 mm batt	TL-93-166	33	38

b) One layer of gypsum board on one side, two layers of gypsum board on other side:

15.9 mm Type X (C)	mineral fibre (M1) 90 mm batt	TL-93-158	36	40
12.7 mm Type X (A)	cellulose (C2) 90 mm blown (54 kg/m ³)	TL-93-175	37	41
12.7 mm (B)	mineral fibre (M1) 90 mm batt	TL-93-167	35	41

c) Two layers of gypsum board on each side:

12.7 mm Type X (A)	cellulose (C2) 90 mm blown (54 kg/m ³)	TL-93-174	38	43
--------------------	--	-----------	----	----

Table WS-2: Wood studs plus resilient furring channels one side with one layer gypsum board each side

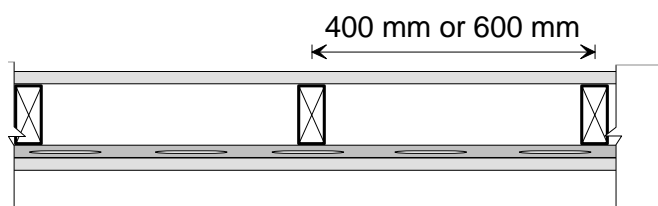

one layer of gypsum board
 38x89 mm wood studs at 400 mm o.c.
 or 600 mm o.c., with absorptive material
 (as noted) in stud cavity
 13 mm resilient furring channels at 600 mm
 or 400 mm o.c.
 one layer of gypsum board

a) Wood studs at 400 mm o.c., resilient furring channels at 600 mm o.c.:

Gypsum Board	Absorptive Material		Test Number	STC	R _w
15.9 mm Type X (C)	none		TL-93-122	40	39
	glass fibre (G1)	89 mm batt	TL-93-110	46	47
	glass fibre (G2)	89 mm batt	TL-93-123	46	48
	mineral fibre (M1)	65 mm batt	TL-93-152	45	47
	mineral fibre (M1)	90 mm batt	TL-93-156	46	48
	cellulose (C1)	45 mm spray (69 kg/m ³)	TL-93-144	48	49
	cellulose (C2)	100 mm blown (54 kg/m ³)	TL-93-105	45	48
12.7 mm Type X (A)	glass fibre (G1)	89 mm batt	TL-93-125	46	48
	glass fibre (G2)	89 mm batt	TL-93-179	46	48
	mineral fibre (M1)	65 mm batt	TL-93-184	42	46
	mineral fibre (M1)	90 mm batt	TL-93-185	45	48
	cellulose (C2)	100 mm blown (48 kg/m ³)	TL-93-171	41	44
12.7 mm Type X (B)	glass fibre (G1)	89 mm batt	TL-93-148	43	46
12.7 mm (B)	glass fibre (G1)	89 mm batt	TL-93-128	42	45
	mineral fibre (M1)	65 mm batt	TL-93-162	40	44
	mineral fibre (M1)	90 mm batt	TL-93-165	41	45
12.7 mm (B-light)	glass fibre (G1)	89 mm batt	TL-94-001	42	44

b) Wood studs at 400 mm o.c., resilient furring channels at 400 mm o.c.:

15.9 mm Type X (C)	glass fibre (G1)	89 mm batt	TL-93-117	43	45
--------------------	------------------	------------	-----------	----	----

c) Wood studs at 600 mm o.c., resilient furring channels at 600 mm o.c.:

15.9 mm Type X (C)	none		TL-93-089	40	39
	glass fibre (G1)	65 mm batt	TL-93-087	48	48
	glass fibre (G1)	89 mm batt	TL-93-083	49	49
	glass fibre (G2)	89 mm batt	TL-93-088	49	48
	mineral fibre (M1)	90 mm batt	TL-93-090	48	49
12.7 mm Type X (A)	glass fibre (G1)	65 mm batt	TL-93-093	47	48

d) Wood studs at 600 mm o.c., resilient furring channels at 400 mm o.c.:

15.9 mm Type X (C)	glass fibre (G1)	89 mm batt	TL-93-098	50	49
--------------------	------------------	------------	-----------	----	----

Table WS-3: Wood studs with resilient furring channels and two layers of gypsum board on one side and one layer of gypsum board on the other side

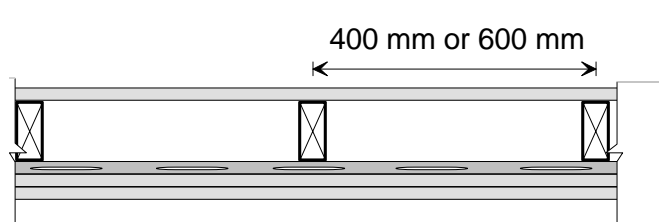

one layer of gypsum board
 38x89 mm wood studs at 400 mm o.c. or 600 mm o.c., with absorptive material (as noted) in stud cavity
 13 mm resilient furring channels at 600 mm or 400 mm o.c.
 two layers of gypsum board

a) Wood studs at 400 mm o.c., resilient furring channels at 600 mm o.c.:

Gypsum Board	Absorptive Material		Test Number	STC	R _w
15.9 mm Type X (C)	glass fibre (G1)	89 mm batt	TL-93-114	53	52
	glass fibre (G2)	89 mm batt	TL-93-124	52	53
	mineral fibre (M1)	65 mm batt	TL-93-153	49	52
	mineral fibre (M1)	90 mm batt	TL-93-155	50	53
	cellulose (C1)	45 mm spray (69 kg/m ³)	TL-93-145	51	53
	cellulose (C2)	100 mm blown (54 kg/m ³)	TL-93-107	50	52
12.7 mm Type X (A)	glass fibre (G1)	89 mm batt	TL-93-126	51	52
	glass fibre (G2)	89 mm batt	TL-93-180	51	52
	mineral fibre (M1)	65 mm batt	TL-93-183	49	51
	mineral fibre (M1)	90 mm batt	TL-93-186	50	52
	cellulose (C2)	100 mm blown (48 kg/m ³)	TL-93-172	48	49
12.7 mm Type X (B)	glass fibre (G1)	89 mm batt	TL-93-150	48	50
12.7 mm (B)	glass fibre (G1)	89 mm batt	TL-93-129	48	50
	mineral fibre (M1)	65 mm batt	TL-93-163	44	48
	mineral fibre (M1)	90 mm batt	TL-93-164	46	49

b) Wood studs at 400 mm o.c., resilient furring channels at 400 mm o.c.:

15.9 mm Type X (C)	glass fibre (G1)	89 mm batt	TL-93-118	50	50
--------------------	------------------	------------	-----------	----	----

c) Wood studs at 600 mm o.c., resilient furring channels at 600 mm o.c.:

15.9 mm Type X (C)	glass fibre (G1)	89 mm batt	TL-93-085	54	54
	mineral fibre (M1)	90 mm batt	TL-93-091	54	54
12.7 mm Type X (A)	glass fibre (G1)	65 mm batt	TL-93-094	54	53
	glass fibre (G1)	89 mm batt	TL-93-097	54	54

d) Wood studs at 600 mm o.c., resilient furring channels at 400 mm o.c.:

15.9 mm Type X (C)	glass fibre (G1)	89 mm batt	TL-93-099	54	53
--------------------	------------------	------------	-----------	----	----

Table WS-4: Wood studs with resilient furring channels and one layer of gypsum board on one side and two layers of gypsum board on the other side

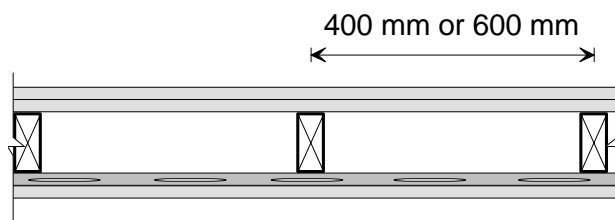

two layers of gypsum board
 38x89 mm wood studs at 400 mm o.c. or
 600 mm o.c., with absorptive material
 (as noted) in stud cavity
 13 mm resilient furring channels at 600
 mm
 or 400 mm o.c.
 one layer of gypsum board

a) Wood studs at 400 mm o.c., resilient furring channels at 600 mm o.c.:

Gypsum Board	Absorptive Material		Test Number	STC	R _w
15.9 mm Type X (C)	glass fibre (G1)	89 mm batt	TL-93-116	53	53
12.7 mm (B-light)	glass fibre (G1)	89 mm batt	TL-94-002	48	49

b) Wood studs at 400 mm o.c., resilient furring channels at 400 mm o.c.:

15.9 mm Type X (C)	glass fibre (G1)	89 mm batt	TL-93-120	50	51
--------------------	------------------	------------	-----------	----	----

c) Wood studs at 600 mm o.c., resilient furring channels at 400 mm o.c.:

15.9 mm Type X (C)	glass fibre (G1)	89 mm batt	TL-93-101	55	54
--------------------	------------------	------------	-----------	----	----

Table WS-5: Wood studs plus resilient furring channels one side with two layers gypsum board each side

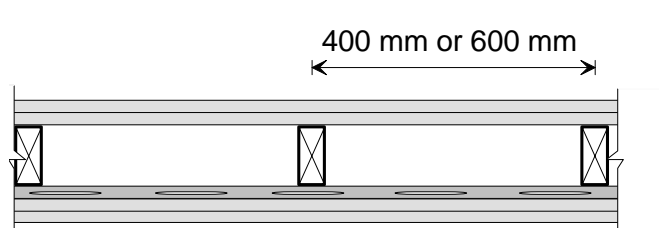

two layers of gypsum board
 38x89 mm wood studs at 400 mm o.c. or 600 mm o.c., with absorptive material (as noted) in stud cavity
 13 mm resilient furring channels at 600 mm or 400 mm o.c.
 two layers of gypsum board

a) Wood studs at 400 mm o.c., resilient furring channels at 600 mm o.c.:

Gypsum Board	Absorptive Material	Test Number	STC	R _w
15.9 mm Type X (C)	glass fibre (G1) 89 mm batt	TL-93-115	59	57
	cellulose (C1) 45 mm spray (69 kg/m ³)	TL-93-146	55	57
	cellulose (C2) 100 mm blown (54 kg/m ³)	TL-93-108	57	57
12.7 mm Type X (A)	glass fibre (G1) 89 mm batt	TL-93-127	57	57
	glass fibre (G2) 89 mm batt	TL-93-181	58	57
	mineral fibre (M1) 90 mm batt	TL-93-187	55	57
	cellulose (C2) 100 mm blown (48 kg/m ³)	TL-93-173	54	55
12.7 mm Type X (B)	glass fibre (G1) 89 mm batt	TL-93-151	53	55
12.7 mm (B)	glass fibre (G1) 89 mm batt	TL-93-130	54	55
12.7 mm (B-light)	glass fibre (G1) 89 mm batt	TL-94-004	53	54

b) Wood studs at 400 mm o.c., resilient furring channels at 400 mm o.c.:

15.9 mm Type X (C)	glass fibre (G1) 89 mm batt	TL-93-119	55	55
--------------------	-----------------------------	-----------	----	----

c) Wood studs at 600 mm o.c, resilient furring channels at 600 mm o.c.:

15.9 mm Type X (C)	glass fibre (G1) 89 mm batt	TL-93-086	59	58
	mineral fibre (M1) 90 mm batt	TL-93-092	59	59
12.7 mm Type X (A)	glass fibre (G1) 65 mm batt	TL-93-095	58	57
	glass fibre (G1) 89 mm batt	TL-93-096	60	58

d) Wood studs at 600 mm o.c., resilient furring channels at 400 mm o.c.:

15.9 mm Type X (C)	glass fibre (G1) 89 mm batt	TL-93-100	57	57
--------------------	-----------------------------	-----------	----	----

Table WS-6: Wood studs at 600 mm o.c. with one layer wood fibreboard each side and one or two layers gypsum board each side

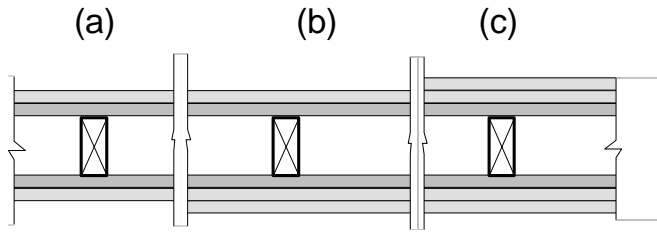

one or two layers of gypsum board
 19 mm wood fibreboard
 38x89 mm wood studs at 600 mm o.c.,
 with absorptive material (as noted) in
 stud cavity
 19 mm wood fibreboard
 one or two layers of gypsum board

a) One layer of gypsum board on each side:

Gypsum Board	Absorptive Material		Test Number	STC	R _w
15.9 mm Type X (C)	glass fibre (G1)	89 mm batt	TL-93-190	49	48

b) One layer of gypsum board on one side, two layers of gypsum board on other side:

15.9 mm Type X (C)	glass fibre (G1)	89 mm batt	TL-93-191	51	50
--------------------	------------------	------------	-----------	----	----

c) Two layers of gypsum board on each side:

15.9 mm Type X (C)	glass fibre (G1)	89 mm batt	TL-93-193	52	50
--------------------	------------------	------------	-----------	----	----

Table SWS-1: Staggered wood studs at 400 mm o.c. on 140 mm plate with one layer gypsum board each side

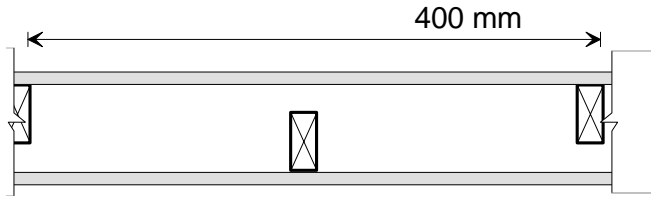

one layer of gypsum board
 38x89 mm staggered wood studs at
 400 mm o.c. on 140 mm plate, with
 absorptive material (as noted) in inter-
 stud cavity
 one layer of gypsum board

Gypsum Board	Absorptive Material	Test Number	STC	R _w
15.9 mm Type X (C)	none	TL-93-254	41	41
	glass fibre (G2) 89 mm batt	TL-93-248	49	48
	glass fibre (G1) 89 mm batt, woven*	TL-93-225	47	47
	glass fibre (G1) both sides 65 mm batt	TL-93-249	50	49
	mineral fibre (M1) 65 mm batt	TL-93-253	46	47
	cellulose (C1) 50 mm spray (62 kg/m ³)	TL-93-242	47	49
	cellulose (C2) 140 mm blown (55 kg/m ³)	TL-93-231	48	48
12.7 mm Type X (A)	glass fibre (G2) 89 mm batt	TL-93-247	47	49
	glass fibre (G1) 89 mm batt, woven*	TL-93-208	45	47
	glass fibre (G1) both sides 65 mm batt	TL-93-198	46	47
	cellulose (C1) 50 mm spray (60 kg/m ³)	TL-93-258	43	47
	cellulose (C2) 140 mm blown (55 kg/m ³)	TL-93-241	45	47
12.7 mm (B)	glass fibre (G1) 89 mm batt, woven*	TL-93-228	43	46
	mineral fibre (M1) 90 mm batt	TL-93-245	43	46
12.7 mm (B-light)	glass fibre (G1) 89 mm batt	TL-93-434	42	45

* "Woven" indicates normal batts of the indicated type, installed so they weave around the studs. Near the studs, they are compressed between the stud and the adjacent gypsum board, as shown in the figure at right.

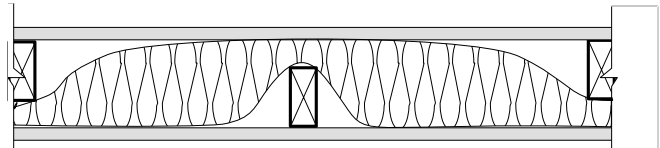

Batts of insulation not described as "woven" were installed in the inter-stud cavities as shown here. Note that most batts are compressed to some degree between studs and the gypsum board on the opposite face.

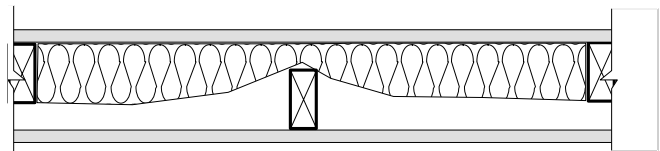
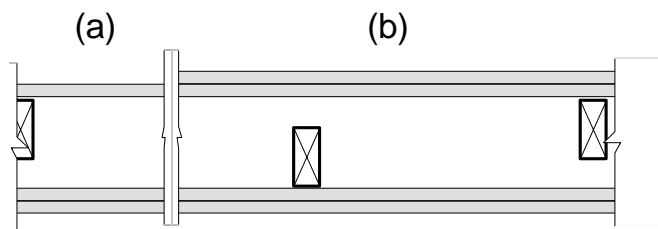

Table SWS-2: Staggered wood studs at 400 mm o.c. on 140 mm plate with one or two layers gypsum board one side and two layers gypsum board other side



one or two layers of gypsum board
 38x89 mm staggered wood studs at
 400 mm o.c. on 140 mm plate, with
 absorptive material (as noted) in inter-
 stud cavity
 two layers of gypsum board

a) One layer of gypsum board on one side, two layers of gypsum board on other side:

Gypsum Board	Absorptive Material	Test Number	STC	R _w	
15.9 mm Type X (C)	glass fibre (G1)	89 mm batt, woven*	TL-93-226	52	52
	glass fibre (G1)	both sides 65 mm batt	TL-93-250	54	53
	mineral fibre (M1)	65 mm batt	TL-93-252	50	51
	cellulose (C1)	50 mm spray (62 kg/m ³)	TL-93-243	53	54
	cellulose (C2)	140 mm blown (55 kg/m ³)	TL-93-232	54	53
12.7 mm Type X (A)	glass fibre (G1)	89 mm batt, woven*	TL-93-209	50	52
	glass fibre (G1)	both sides 65 mm batt	TL-93-201	51	52
	glass fibre (G1)	65 mm batt	TL-93-440	52	51
12.7 mm (B)	glass fibre (G1)	89 mm batt, woven*	TL-93-229	49	51
12.7 mm (B-light)	glass fibre (G1)	89 mm batt	TL-93-435	48	50

b) Two layers of gypsum board on each side:

15.9 mm Type X (C)	glass fibre (G1)	89 mm batt, woven*	TL-93-227	56	56
	glass fibre (G1)	both sides 65 mm batt	TL-93-251	57	56
	cellulose (C2)	140 mm blown (55 kg/m ³)	TL-93-233	57	56
12.7 mm Type X (A)	glass fibre (G1)	89 mm batt, woven*	TL-93-210	55	56
	glass fibre (G1)	both sides 65 mm batt	TL-93-202	56	56
12.7 mm (B)	none		TL-93-246	47	48
	glass fibre (G1)	89 mm batt, woven*	TL-93-230	54	55
	glass fibre (G1)	89 mm batt	TL-93-421	55	54
12.7 mm (B-light)	glass fibre (G1)	89 mm batt	TL-93-436	53	54

* Note: See Figure below Table SWS-1.

Table SWS-3: Staggered wood studs at 400 mm o.c. on 140 mm plate plus resilient furring channels one side with one or two layers gypsum board each side

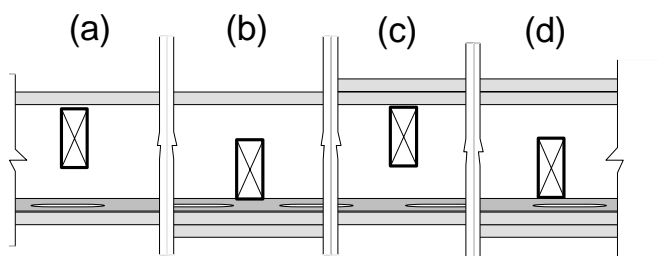

one or two layers of gypsum board
 38x89 mm staggered wood studs at
 400 mm o.c. on 140 mm plate, with
 absorptive material (as noted) in inter-
 stud cavity
 13 mm resilient furring channels at
 600 mm o.c.
 one or two layers of gypsum board

a) One layer of gypsum board on each side plus resilient furring channels on one side:

Gypsum Board	Absorptive Material		Test Number	STC	R _w
15.9 mm Type X (C)	glass fibre (G1)	89 mm batt, woven*	TL-93-214	51	52
	cellulose (C1)	50 mm spray (62 kg/m ³)	TL-93-244	52	53
	cellulose (C2)	140 mm blown (55 kg/m ³)	TL-93-238	53	54
12.7 mm Type X (A)	glass fibre (G1)	89 mm batt, woven*	TL-93-213	49	52
	cellulose (C1)	50 mm spray (60 kg/m ³)	TL-93-259	48	51
	cellulose (C2)	140 mm blown (55 kg/m ³)	TL-93-239	49	51

b) One layer of gypsum board one side, two layers of gypsum board plus resilient furring channels other side:

15.9 mm Type X (C)	glass fibre (G1)	89 mm batt, woven*	TL-93-215	56	57
	cellulose (C2)	140 mm blown (55 kg/m ³)	TL-93-237	57	59
12.7 mm Type X (A)	glass fibre (G1)	89 mm batt, woven*	TL-93-212	54	57
	cellulose (C2)	140 mm blown (55 kg/m ³)	TL-93-240	54	56

c) Two layers of gypsum board on one side, one layer gypsum board plus resilient furring channels other side:

15.9 mm Type X (C)	cellulose (C2)	140 mm blown (55 kg/m ³)	TL-93-235	57	58
--------------------	----------------	--------------------------------------	-----------	----	----

d) Two layers of gypsum board on each side plus resilient furring channels on one side:

15.9 mm Type X (C)	cellulose (C2)	140 mm blown (55 kg/m ³)	TL-93-236	62	64
	glass fibre (G1)	89 mm batt, woven*	TL-93-216	62	62
12.7 mm Type X (A)	glass fibre (G1)	89 mm batt, woven*	TL-93-211	60	62

* Note: See Figure below Table SWS-1.

Table SWS-4: Staggered wood studs at 600 mm o.c. on 140 mm plate with one layer gypsum board each side

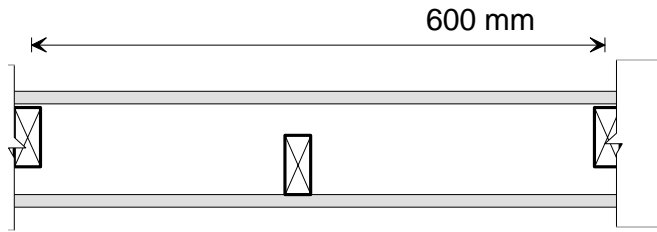

one layer of gypsum board
 38x89 mm staggered wood studs at
 600 mm o.c. on 140 mm plate, with
 absorptive material (as noted) in inter-
 stud cavity
 one layer of gypsum board

Gypsum Board	Absorptive Material		Test Number	STC	R _w
15.9 mm Type X (C)	glass fibre (G1)	89 mm batt, woven*	TL-93-256	48	48
	glass fibre (G1)	65 mm batt both sides	TL-93-255	48	48
12.7 mm Type X (A)	glass fibre (G1)	89 mm batt, woven*	TL-93-257	49	48

* Note: See Figure below Table SWS-1.

Table DWS-1: Double wood studs at 400 mm o.c. with one or two layers gypsum board each side

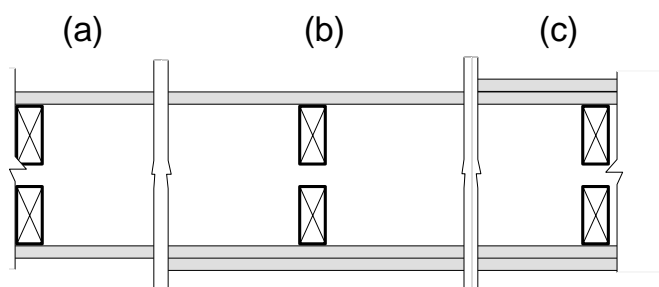

one or two layers of gypsum board
 38x89 mm wood studs at 400 mm o.c.,
 with absorptive material (as noted) in
 inter-stud cavity
 25 mm air space
 38x89 mm wood studs at 400 mm o.c.,
 with absorptive material (as noted) in
 inter-stud cavity
 one or two layers of gypsum board

a) One layer of gypsum board on each side:

Gypsum Board	Absorptive Material	Test Number	STC	R _w
15.9 mm Type X (C)	none	TL-93-261	45	46
	glass fibre (G1) 89 mm batt	TL-93-265	55	55
	glass fibre (G1) both sides 65 mm batt	TL-93-262	58	59
	glass fibre (G1) both sides 89 mm batt	TL-93-266	56	58
	glass fibre (G2) both sides 89 mm batt	TL-93-263	58	59
	mineral fibre (M1) both sides 89 mm batt	TL-93-264	57	59
12.7 mm Type X (A)	glass fibre (G1) 89 mm batt	TL-93-279	53	54
	glass fibre (G1) both sides 65 mm batt	TL-93-277	56	57
	glass fibre (G1) both sides 89 mm batt	TL-93-270	58	58
	glass fibre (G2) both sides 89 mm batt	TL-93-278	57	57
12.7 mm (B)	glass fibre (G1) both sides 89 mm batt	TL-93-273	54	55

b) One layer of gypsum board on one side, two layers of gypsum board on other side:

15.9 mm Type X (C)	glass fibre (G1) both sides 89 mm batt	TL-93-267	62	64
12.7 mm Type X (A)	glass fibre (G1) both sides 89 mm batt	TL-93-271	62	63
12.7 mm (B)	glass fibre (G1) both sides 89 mm batt	TL-93-274	59	60

c) Two layers of gypsum board on each side:

15.9 mm Type X (C)	glass fibre (G1) both sides 89 mm batt	TL-93-269	67	69
12.7 mm Type X (A)	glass fibre (G1) both sides 89 mm batt	TL-93-272	66	68
12.7 mm (B)	none	TL-93-276	55	54
	glass fibre (G1) both sides 89 mm batt	TL-93-275	64	65

Table DWS-2: Double wood studs at 600 mm o.c. with one or two layer gypsum board each side

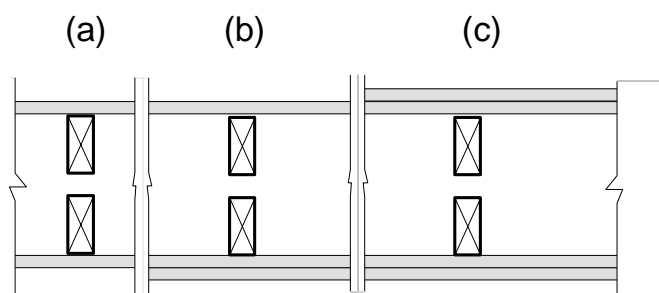

one or two layers of gypsum board
 38x89 mm wood studs at 600 mm o.c.,
 with absorptive material (as noted) in
 inter-stud cavity
 25 mm air space
 38x89 mm wood studs at 600 mm o.c.,
 with absorptive material (as noted) in
 inter-stud cavity
 one or two layers of gypsum board

a) One layer of gypsum board on each side:

Gypsum Board	Absorptive Material	Test Number	STC	R _w	
15.9 mm Type X (C)	glass fibre (G1)	both sides 89 mm batt	TL-93-281	59	60
	cellulose (C1)	60 mm spray (65 kg/m ³)	TL-93-311	58	57
	cellulose (C2)	110 mm blown (55 kg/m ³)	TL-93-295	57	58
15.9 mm Type X (B)	glass fibre (G1)	both sides 89 mm batt	TL-93-293	59	60
15.9 mm Type X (A)	glass fibre (G1)	both sides 89 mm batt	TL-93-292	59	60
12.7 mm Type X (A)	glass fibre (G1)	both sides 89 mm batt	TL-93-288	57	58
	cellulose (C1)	55 mm spray (46 kg/m ³)	TL-93-356	56	55
	cellulose (C2)	110 mm blown (55 kg/m ³)	TL-93-296	55	57
12.7 mm Type X (B)	glass fibre (G1)	both sides 89 mm batt	TL-93-290	57	58
12.7 mm Type X (C)	glass fibre (G1)	both sides 89 mm batt	TL-93-289	55	56
12.7 mm (B)	glass fibre (G1)	both sides 89 mm batt	TL-93-284	54	55
12.7 mm (A)	glass fibre (G1)	both sides 89 mm batt	TL-93-291	53	54
12.7 mm (C)	glass fibre (G1)	both sides 89 mm batt	TL-93-294	54	55

b) One layer of gypsum board on one side, two layers of gypsum board on other side:

15.9 mm Type X (C)	glass fibre (G1)	both sides 89 mm batt	TL-93-282	64	65
	cellulose (C1)	60 mm spray (65 kg/m ³)	TL-93-312	62	61
12.7 mm (B)	glass fibre (G1)	both sides 89 mm batt	TL-93-285	59	60

c) Two layers of gypsum board on each side:

15.9 mm Type X (C)	glass fibre (G1)	both sides 89 mm batt	TL-93-283	69	69
	cellulose (C1)	60 mm spray (65 kg/m ³)	TL-93-313	66	65
12.7 mm (B)	none		TL-93-287	55	54
	glass fibre (G1)	both sides 89 mm batt	TL-93-286	65	65

Table DWS-3: Double wood studs at 400 mm o.c. with one layer fibreboard between studs and one layer gypsum board each side

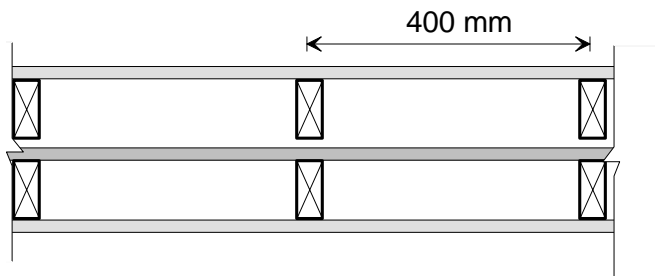

one layer of gypsum board
 38x89 mm wood studs at 400 mm o.c.,
 with absorptive material (as noted) in
 inter-stud cavity
 25 mm air space
 19 mm fibreboard
 38x89 mm wood studs at 400 mm o.c.,
 with absorptive material (as noted) in
 inter-stud cavity
 one layer of gypsum board

Gypsum Board	Absorptive Material	Test Number	STC	R _w
15.9 mm Type X (C)	glass fibre (G1) both sides 65 mm batt	TL-93-280	54	56

Table DWS-4: Double wood studs at 400 mm o.c. with one layer gypsum board between studs and one layer gypsum board each side

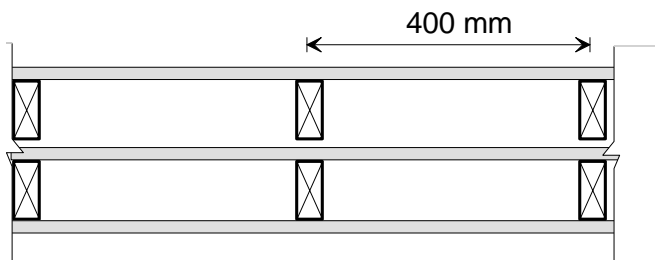

one layer of gypsum board
 38x89 mm wood studs at 400 mm o.c.,
 with absorptive material (as noted) in
 inter-stud cavity
 25 mm air space
 15.9 mm gypsum board, Type X
 38x89 mm wood studs at 400 mm o.c.,
 with absorptive material (as noted) in
 inter-stud cavity
 one layer of gypsum board

Gypsum Board	Absorptive Material	Test Number	STC	R _w
15.9 mm Type X (C)	glass fibre (G1) both sides 65 mm batt	TL-93-297	55	57

Table SS-1: 31x92 mm, 25 gauge (0.50 mm) non-loadbearing steel studs at 400 mm o.c. with one or two layers gypsum board each side

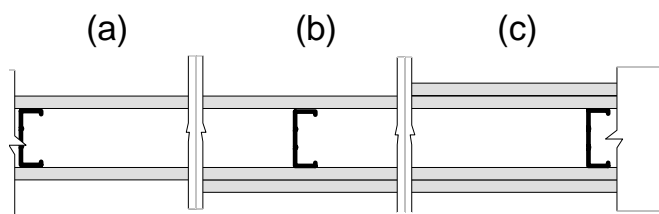

one or two layers of gypsum board
 31x92 mm 25 gauge (0.50 mm)
 non-loadbearing steel studs at
 400 mm o.c., with absorptive material
 (as noted) in stud cavity
 one or two layers of gypsum board

a) One layer of gypsum board on each side:

Gypsum Board	Absorptive Material		Test Number	STC	R _w
15.9 mm Type X (C)	none		TL-92-418	38	39
	glass fibre (G1)	89 mm batt	TL-93-325	49	47
	mineral fibre (M1)	90 mm batt	TL-93-327	47	47
	mineral fibre (M2)	40 mm batt	TL-93-340	41	44
	mineral fibre (M2)	75 mm batt	TL-93-335	45	46
	mineral fibre (M3)	83 mm batt	TL-93-338	41	44
	cellulose (C1)	45 mm spray (46 kg/m ³)	TL-92-439	45	46
cellulose (C1)	90 mm spray (46 kg/m ³)	TL-93-049	45	46	
12.7 mm Type X (A)	glass fibre (G1)	89 mm batt	TL-93-344	46	45
	mineral fibre (M2)	40 mm batt	TL-93-343	40	43
	mineral fibre (M3)	83 mm batt	TL-93-339	40	44
12.7 mm Type X (B)	glass fibre (G1)	89 mm batt	TL-92-425	45	44
12.7 mm (A)	glass fibre (G1)	89 mm batt	TL-93-365	40	42
12.7 mm (B)	glass fibre (G1)	89 mm batt	TL-92-428	42	43
12.7 mm (B-lite)	glass fibre (G1)	89 mm batt	TL-93-361	39	41

Table SS-1:(Continued)

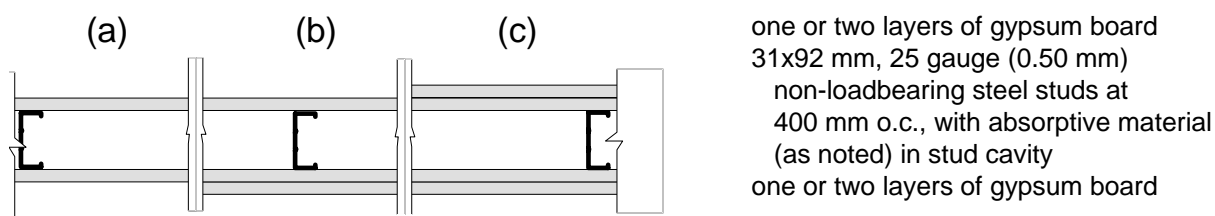

b) One layer of gypsum board on one side, two layers of gypsum board on other side:

Gypsum Board	Absorptive Material		Test Number	STC	R _w
15.9 mm Type X (C)	glass fibre (G1)	89 mm batt	TL-92-420	52	50
	mineral fibre (M1)	90 mm batt	TL-93-329	53	52
	mineral fibre (M2)	40 mm batt	TL-93-341	47	49
	mineral fibre (M2)	75 mm batt	TL-93-333	50	50
	mineral fibre (M3)	83 mm batt	TL-93-337	46	48
	cellulose (C1)	45 mm spray (46 kg/m ³)	TL-92-440	51	50
	cellulose (C1)	90 mm spray (46 kg/m ³)	TL-93-050	49	49
	cellulose (C2)	90 mm blown (46 kg/m ³)	TL-92-437	49	50
12.7 mm Type X (A)	glass fibre (G1)	89 mm batt	TL-93-345	51	50
12.7 mm Type X (B)	glass fibre (G1)	89 mm batt	TL-92-426	50	49
12.7 mm (A)	glass fibre (G1)	89 mm batt	TL-93-366	46	47
12.7 mm (B)	glass fibre (G1)	89 mm batt	TL-92-429	48	48
12.7 mm (B-lite)	glass fibre (G1)	89 mm batt	TL-93-364	44	46

c) Two layers of gypsum board on each side:

15.9 mm Type X (C)	glass fibre (G1)	89 mm batt	TL-93-351	56	55
	mineral fibre (M1)	90 mm batt	TL-93-332	55	55
	mineral fibre (M2)	40 mm batt	TL-93-342	52	53
	mineral fibre (M2)	75 mm batt	TL-93-334	54	54
	cellulose (C1)	45 mm spray (46 kg/m ³)	TL-92-441	53	53
	cellulose (C1)	90 mm spray (46 kg/m ³)	TL-93-051	52	53
	cellulose (C2)	90 mm blown (46 kg/m ³)	TL-92-435	54	53
12.7 mm Type X (A)	glass fibre (G1)	89 mm batt	TL-92-424	55	53
12.7 mm Type X (B)	glass fibre (G1)	89 mm batt	TL-92-427	55	53
12.7 mm (A)	glass fibre (G1)	89 mm batt	TL-93-367	53	52
12.7 mm (B)	glass fibre (G1)	89 mm batt	TL-92-430	53	52
12.7 mm (B-lite)	glass fibre (G1)	89 mm batt	TL-93-363	48	49

Table SS-2: 31x92 mm, 25 gauge (0.50 mm) non-loadbearing steel studs at 600 mm o.c. with one or two layers gypsum board each side

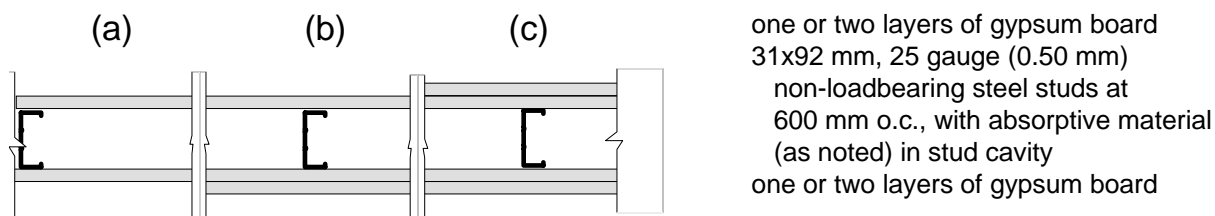

a) One layer of gypsum board on each side:

Gypsum Board	Absorptive Material		Test Number	STC	R _w
15.9 mm Type X (C)	none		TL-92-376	38	39
	glass fibre (G1)	89 mm batt	TL-92-349	49	48
	mineral fibre (M2)	40 mm batt	TL-92-396	45	45
12.7 mm Type X (A)	glass fibre (G1)	89 mm batt	TL-92-410	48	47
	cellulose (C2)	90 mm blown (38 kg/m ³)	TL-93-026	48	47
12.7 mm (B)	glass fibre (G1)	89 mm batt	TL-92-413	47	45

b) One layer of gypsum board on one side, two layers of gypsum board on other side:

15.9 mm Type X (C)	glass fibre (G1)	89 mm batt	TL-92-368	54	53
	mineral fibre (M2)	40 mm batt	TL-92-397	51	50
12.7 mm Type X (A)	glass fibre (G1)	89 mm batt	TL-92-411	52	52
	cellulose (C2)	90 mm blown (38 kg/m ³)	TL-93-027	53	52
12.7 mm (B)	glass fibre (G1)	89 mm batt	TL-92-415	51	50

c) Two layers of gypsum board on each side:

15.9 mm Type X (C)	glass fibre (G1)	89 mm batt	TL-92-369	57	55
	mineral fibre (M2)	40 mm batt	TL-92-398	55	53
12.7 mm Type X (A)	glass fibre (G1)	89 mm batt	TL-92-412	55	54
	cellulose (C2)	90 mm blown (38 kg/m ³)	TL-93-028	56	55
12.7 mm (B)	glass fibre (G1)	89 mm batt	TL-92-416	53	52

Table SS-3: 31x92 mm, 25 gauge (0.50 mm) non-loadbearing steel studs at 600 mm o.c. with one or two layers of Type X gypsum board each side plus an additional layer of regular gypsum board on one side

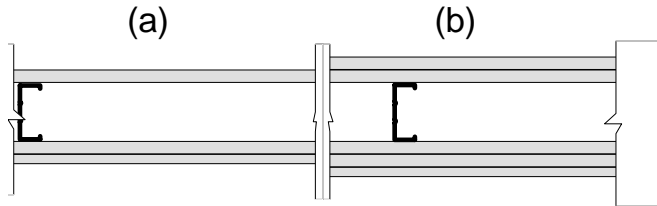

one or two layers of Type X gypsum board
 31x92 mm, 25 gauge (0.50 mm)
 non-loadbearing steel studs at
 600 mm o.c., with absorptive material
 (as noted) in stud cavity
 one or two layers of Type X gypsum board
 one layer of regular gypsum board

a) One layer of 15.9 mm Type X gypsum board (C) on each side plus an additional layer of 12.7 mm gypsum board (B) on one side:

Gypsum Board	Absorptive Material	Test Number	STC	R _w
Two types	glass fibre (G1) 89 mm batt	TL-92-370	55	53

b) Two layers of 15.9 mm Type X gypsum board (C) on each side plus an additional layer of 12.7 mm gypsum board (B) on one side:

Two types	none	TL-92-371	54	53
-----------	------	-----------	----	----

NOTE: These walls were included to show the effect of retrofitting an existing wall with the addition of a single layer of regular gypsum board.

Table SS-4: 31x64 mm, 25 gauge (0.50 mm) non-loadbearing steel studs at 400 mm o.c. with one or two layers gypsum board each side

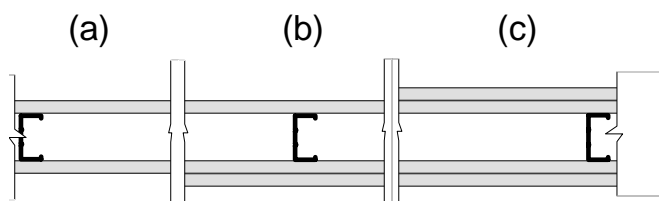

one or two layers of gypsum board
 31x64 mm, 25 gauge (0.50 mm)
 non-loadbearing steel studs at
 400 mm o.c., with absorptive material
 (as noted) in stud cavity
 one or two layers of gypsum board

a) One layer of gypsum board on each side:

Gypsum Board	Absorptive Material	Test Number	STC	R _w
15.9 mm Type X (C)	none	TL-93-057	35	36
	glass fibre (G1) 65 mm batt	TL-93-058	39	42
	mineral fibre (M1) 65 mm batt	TL-93-061	38	43
	mineral fibre (M2) 65 mm batt	TL-93-059	36	42
	mineral fibre (M3) 57 mm batt	TL-93-060	36	41
12.7 mm Type X (A)	mineral fibre (M1) 65 mm batt	TL-93-064	36	41
	mineral fibre (M2) 65 mm batt	TL-93-067	35	41
	mineral fibre (M3) 57 mm batt	TL-93-068	36	41
12.7 mm (B)	mineral fibre (M1) 65 mm batt	TL-93-070	34	40

b) One layer of gypsum board on one side, two layers of gypsum board on other side:

15.9 mm Type X (C)	mineral fibre (M1) 65 mm batt	TL-93-062	45	47
12.7 mm Type X (A)	mineral fibre (M1) 65 mm batt	TL-93-065	42	46
12.7 mm (B)	mineral fibre (M1) 65 mm batt	TL-93-071	38	44

c) Two layers of gypsum board on each side:

15.9 mm Type X (C)	mineral fibre (M1) 65 mm batt	TL-93-063	52	52
12.7 mm Type X (A)	mineral fibre (M1) 65 mm batt	TL-93-066	48	50
12.7 mm (B)	mineral fibre (M1) 65 mm batt	TL-93-072	44	48

Table SS-5: 31x64 mm, 25 gauge (0.50 mm) non-loadbearing steel studs at 600 mm o.c. with one or two layers gypsum board each side

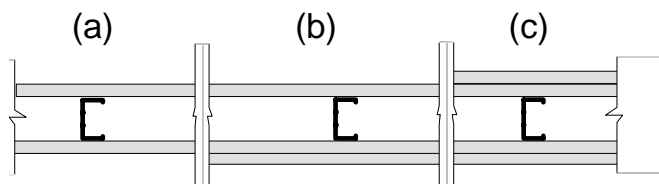

one or two layers of gypsum board
 31x64 mm, 25 gauge (0.50 mm)
 non-loadbearing steel studs at
 600 mm o.c., with absorptive material
 (as noted) in stud cavity
 one or two layers of gypsum board

a) One layer of gypsum board on each side:

Gypsum Board	Absorptive Material	Test Number	STC	R _w
15.9 mm Type X (C)	none	TL-93-032	35	37
	glass fibre (G1) 65 mm batt	TL-93-033	44	44
	mineral fibre (M1) 65 mm batt	TL-93-034	42	44
12.7 mm Type X (A)	glass fibre (G1) 65 mm batt	TL-93-038	45	44
	mineral fibre (M1) 65 mm batt	TL-93-047	43	45
12.7 mm (B)	glass fibre (G1) 65 mm batt	TL-93-043	43	43

b) One layer of gypsum board on one side, two layers of gypsum board on other side:

15.9 mm Type X (C)	glass fibre (G1) 65 mm batt	TL-93-036	51	49
12.7 mm Type X (A)	glass fibre (G1) 65 mm batt	TL-93-039	51	49
	mineral fibre (M1) 65 mm batt	TL-93-055	49	49
12.7 mm (B)	glass fibre (G1) 65 mm batt	TL-93-045	49	47

c) Two layers of gypsum board on each side:

15.9 mm Type X (C)	glass fibre (G1) 65 mm batt	TL-93-037	55	53
12.7 mm Type X (A)	glass fibre (G1) 65 mm batt	TL-93-040	55	54
	mineral fibre (M1) 65 mm batt	TL-93-056	54	53
12.7 mm (B)	glass fibre (G1) 65 mm batt	TL-93-046	52	50

Table SS-6: 31x64 mm, 25 gauge (0.50 mm) non-loadbearing steel studs at 600 mm o.c. with one layer of Type X gypsum board each side with an additional layer of regular gypsum board on one side

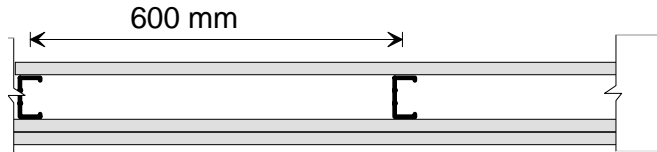

one layer of Type X gypsum board
 31x64 mm, 25 gauge (0.50 mm)
 non-loadbearing steel studs at
 600 mm o.c., with absorptive material
 (as noted) in stud cavity
 one layer of Type X gypsum board
 one layer of regular gypsum board

a) One layer of 15.9 mm Type X gypsum board (C) on each side plus an additional layer of 12.7 mm gypsum board (B) on one side:

Gypsum Board	Absorptive Material	Test Number	STC	R _w
Two types	glass fibre (G1) 65 mm batt	TL-93-035	49	49

b) One layer of 12.7 mm Type X gypsum board (A) on each side plus an additional layer of 12.7 mm gypsum board (B) on one side:

Two types	mineral fibre (M1) 65 mm batt	TL-93-048	48	49
-----------	-------------------------------	-----------	----	----

NOTE: These walls were included to show the effect of retrofitting an existing wall with the addition of a single layer of regular gypsum board.

Table SS-7: 31x152 mm, 25 gauge (0.50 mm) non-loadbearing steel studs at 600 mm o.c. with one layer gypsum board each side

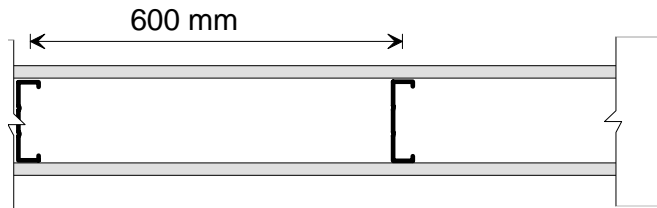

one layer of gypsum board
 31x152 mm, 25 gauge (0.50 mm)
 non-loadbearing steel studs at
 600 mm o.c., with absorptive material
 (as noted) in stud cavity
 one layer of gypsum board

Gypsum Board	Absorptive Material		Test Number	STC	R _w
15.9 mm Type X (C)	glass fibre (G1)	150 mm batt	TL-93-298	51	51
12.7 mm Type X (A)	glass fibre (G1)	150 mm batt	TL-93-299	52	52

Table SS-8: Chase wall - two rows of 31x64 mm, 25 gauge (0.50 mm) non-loadbearing steel studs at 600 mm o.c. with one or two layers gypsum board one side and one or two layers gypsum board other side, studs bridged at midpoint by 12.7 mm x 300 mm gypsum board gussets

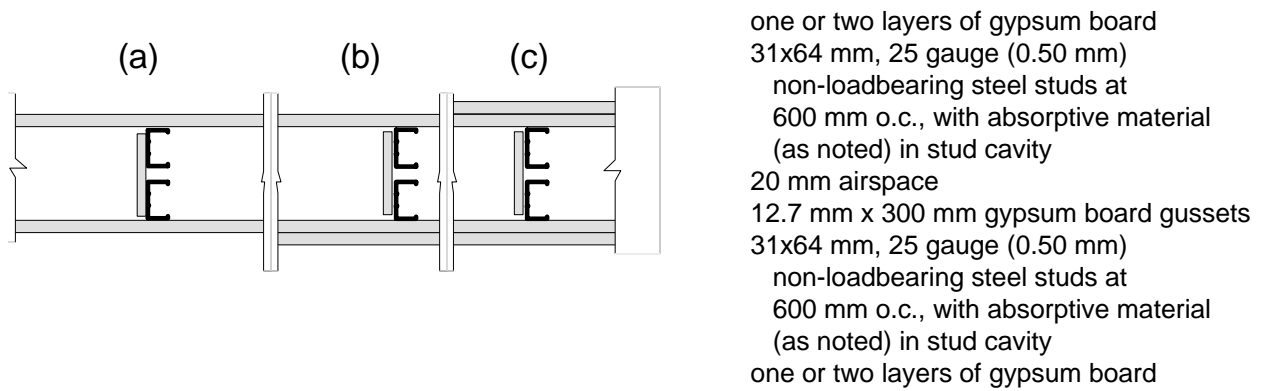

a) One layer of gypsum board on each side:

Gypsum Board	Absorptive Material	Test Number	STC	R _w
15.9 mm Type X (C)	glass fibre (G1) both sides 65 mm batt	TL-93-300	55	55
12.7 mm Type X (A)	glass fibre (G1) both sides 65 mm batt	TL-93-303	54	54

b) One layer of gypsum board on one side, two layers of gypsum board on other side:

15.9 mm Type X (C)	glass fibre (G1) both sides 65 mm batt	TL-93-301	61	60
12.7 mm Type X (A)	glass fibre (G1) both sides 65 mm batt	TL-93-304	60	59

c) Two layers of gypsum board on each side:

15.9 mm Type X (C)	glass fibre (G1) both sides 65 mm batt	TL-93-302	64	63
12.7 mm Type X (A)	glass fibre (G1) both sides 65 mm batt	TL-93-305	62	62

Table SS-9: Chase wall - two rows of 31x41 mm, 25 gauge (0.50 mm) non-loadbearing steel studs at 600 mm o.c. with one or two layers gypsum board one side and one or two layers gypsum board other side, studs bridged at midpoint by 12.7 mm x 300 mm gypsum board gussets

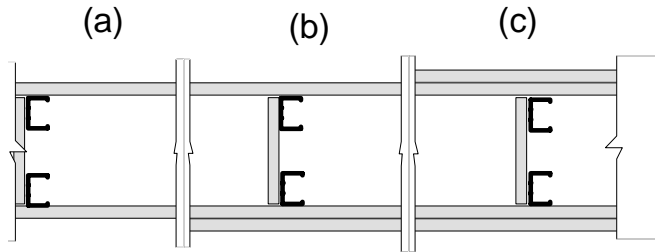

one or two layers of gypsum board
 31x41 mm, 25 gauge (0.50 mm)
 non-loadbearing steel studs at
 600 mm o.c., with absorptive material
 (as noted) in stud cavity
 65 mm airspace
 12.7 mm x 300 mm gypsum board gussets
 31x41 mm, 25 gauge (0.50 mm)
 non-loadbearing steel studs at
 600 mm o.c., with absorptive material
 (as noted) in stud cavity
 one or two layers of gypsum board

a) One layer of gypsum board on each side:

Gypsum Board	Absorptive Material		Test Number	STC	R _w
15.9 mm Type X (C)	mineral fibre (M2)	both sides 40 mm batt	TL-93-309	54	55
12.7 mm Type X (A)	mineral fibre (M2)	both sides 40 mm batt	TL-93-306	53	54

b) One layer of gypsum board on one side, two layers of gypsum board on other side:

12.7 mm Type X (A)	mineral fibre (M2)	both sides 40 mm batt	TL-93-307	59	59
--------------------	--------------------	-----------------------	-----------	----	----

c) Two layers of gypsum board on each side:

15.9 mm Type X (C)	mineral fibre (M2)	both sides 40 mm batt	TL-93-321	65	64
12.7 mm Type X (A)	mineral fibre (M2)	both sides 40 mm batt	TL-93-308	63	62

Table SS-10: 41x152 mm, 18 gauge (1.22 mm) loadbearing steel studs at 400 mm o.c. plus resilient furring channels one side with one layer gypsum board each side

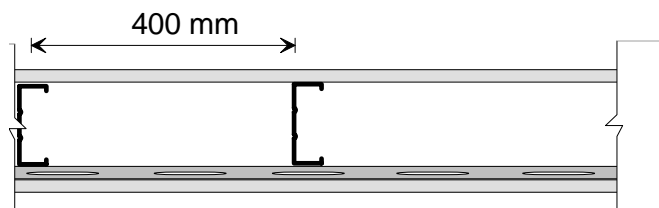

one layer of gypsum board
 41x152 mm, 18 gauge (1.22 mm) load-bearing steel studs at 400 mm o.c., with absorptive material (as noted) in stud cavity
 13 mm resilient furring channels at 600 mm o.c.
 one layer of gypsum board

Gypsum Board	Absorptive Material	Test Number	STC	R _w
15.9 mm Type X (C)	glass fibre (G1) 89 mm batt	TL-93-353	50	49

Table SS-11: 41x92 mm 16 gauge (1.52 mm), 18 gauge (1.22 mm) or 20 gauge (0.91 mm) loadbearing steel studs at 400 mm o.c. plus resilient furring channels one side with one layer gypsum board each side

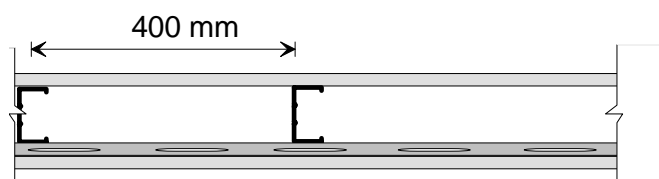

one layer of gypsum board
 41x92 mm, 16 gauge (1.52), 18 gauge (1.22 mm) or 20 gauge (0.91 mm) loadbearing steel studs at 400 mm o.c., with absorptive material (as noted) in stud cavity
 13 mm resilient furring channels at 600 mm o.c.
 one layer of gypsum board

a) 16 gauge (1.52 mm) steel studs

Gypsum Board	Absorptive Material	Test Number	STC	R _w
15.9 mm Type X (C)	glass fibre (G1) 89 mm batt	TL-93-355	49	48

b) 18 gauge (1.22 mm) steel studs

15.9 mm Type X (C)	glass fibre (G1)	89 mm batt	TL-93-354	50	49
--------------------	------------------	------------	-----------	----	----

Note: This is a valid test result for this specific specimen, but comparison with results for other entries in the tables suggests repeated testing might give a lower STC.

c) 20 gauge (0.91 mm) steel studs

15.9 mm Type X (C)	glass fibre (G1)	89 mm batt	TL-94-025	49	49
12.7 mm Type X (A)	glass fibre (G1)	89 mm batt	TL-94-022	48	49

Table SS-12: 41x92 mm 16 gauge (1.52 mm) or 20 gauge (0.91 mm) loadbearing steel studs at 400 mm o.c. plus resilient furring channels one side with one or two layers gypsum board each side

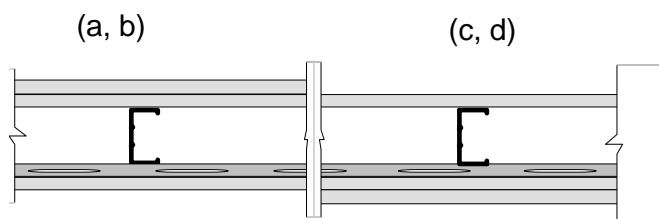

one or two layers of gypsum board
 41x92 mm, 16 gauge (1.52 mm) or
 20 gauge (0.91 mm) loadbearing steel
 studs at 400 mm o.c., with absorptive
 material (as noted) in stud cavity
 13 mm resilient furring channels at
 600 mm o.c.
 one or two layers of gypsum board

a) 16 gauge (1.52 mm) steel studs, two layers of gypsum board one side, one layer of gypsum board plus resilient furring channels other side:

Gypsum Board	Absorptive Material	Test Number	STC	R _w
12.7 mm Type X (A)	glass fibre (G1) 89 mm batt	TL-94-016	53	52
	mineral fibre (M1) 90 mm batt	TL-94-013	53	53

b) 20 gauge (0.91 mm) steel studs, two layers of gypsum board one side, one layer of gypsum board plus resilient furring channels other side:

12.7 mm Type X (A)	glass fibre (G1) 89 mm batt	TL-94-019	54	54
	mineral fibre (M1) 90 mm batt	TL-94-023	54	55

c) 16 gauge (1.52 mm) steel studs, one layer of gypsum board one side, two layers of gypsum board plus resilient furring channels other side:

12.7 mm Type X (A)	glass fibre (G1) 89 mm batt	TL-94-018	53	53
--------------------	-----------------------------	-----------	----	----

d) 20 gauge (0.91 mm) steel studs, one layer of gypsum board one side, two layers of gypsum board plus resilient furring channels other side:

12.7 mm Type X (A)	glass fibre (G1) 89 mm batt	TL-94-021	54	55
--------------------	-----------------------------	-----------	----	----

Table SS-13: 41x92 mm, 16 gauge (1.52 mm) or 20 gauge (0.91 mm) loadbearing steel studs at 400 mm o.c. plus resilient furring channels one side with two layers gypsum board each side

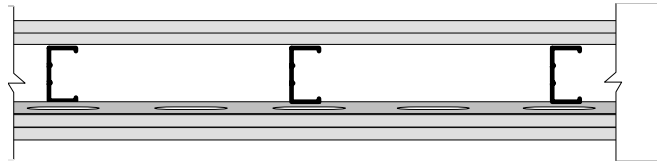

two layers of gypsum board
 41x92 mm, 16 gauge (1.52 mm) or
 20 gauge (0.91 mm) loadbearing steel
 studs at 400 mm o.c., with absorptive
 material (as noted) in stud cavity
 13 mm resilient furring channels at
 600 mm o.c.
 two layers of gypsum board

a) 16 gauge (1.52 mm) steel studs:

Gypsum Board	Absorptive Material		Test Number	STC	R _w
12.7 mm Type X (A)	glass fibre (G1)	89 mm batt	TL-94-017	59	57
	mineral fibre (M1)	90 mm batt	TL-94-014	59	58

b) 20 gauge (0.91 mm) steel studs:

12.7 mm Type X (A)	glass fibre (G1)	89 mm batt	TL-94-020	60	59
	mineral fibre (M1)	90 mm batt	TL-94-024	60	60

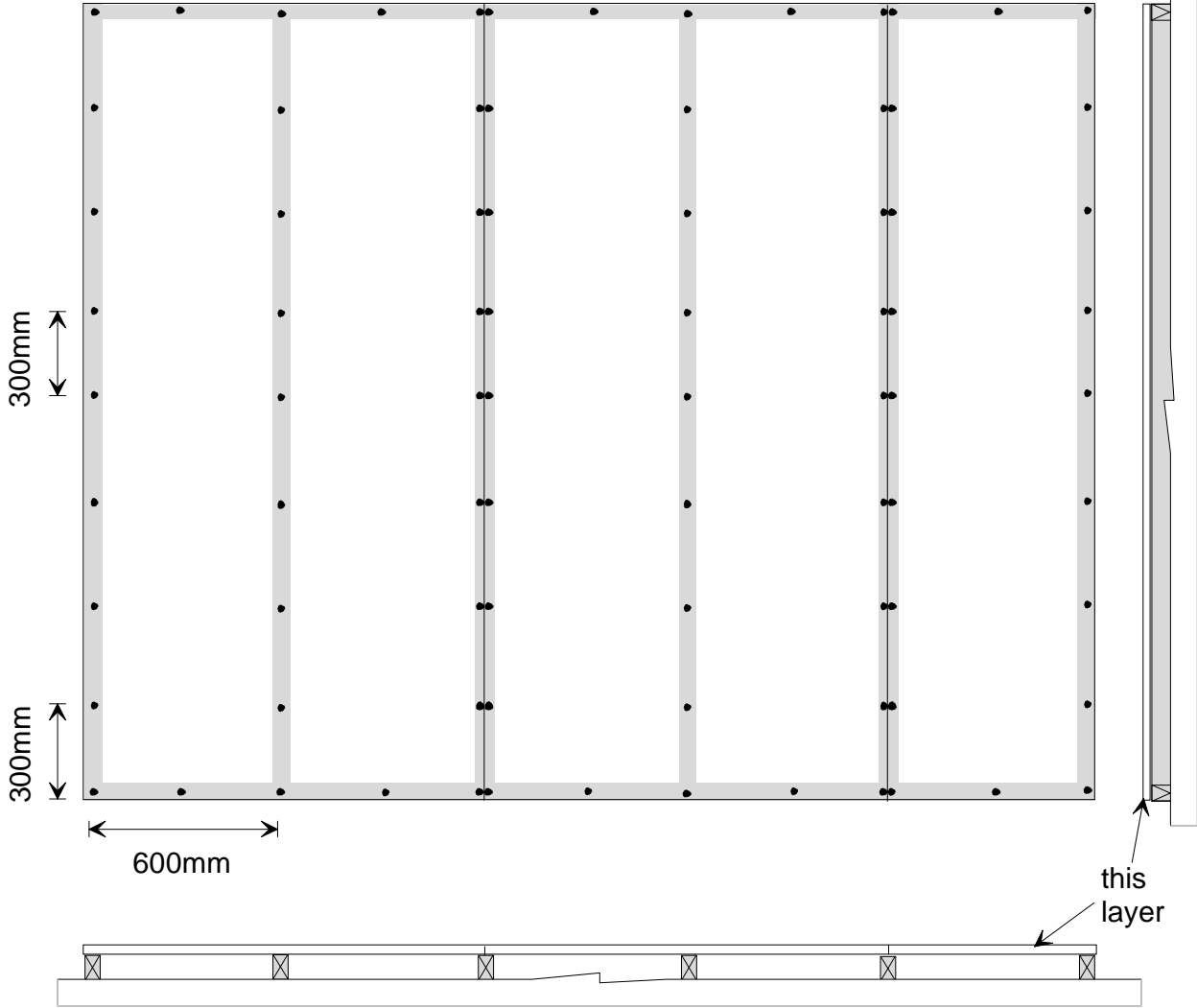

Figure A-1: Single-ply gypsum board attached parallel to wood studs at 600 mm o.c., single plates at top and bottom. Meets requirements of CAN/CSA-A82.31-M91, Clause 7.3.4, and National Building Code of Canada Section 9.29.5.9. Drawing not to scale.

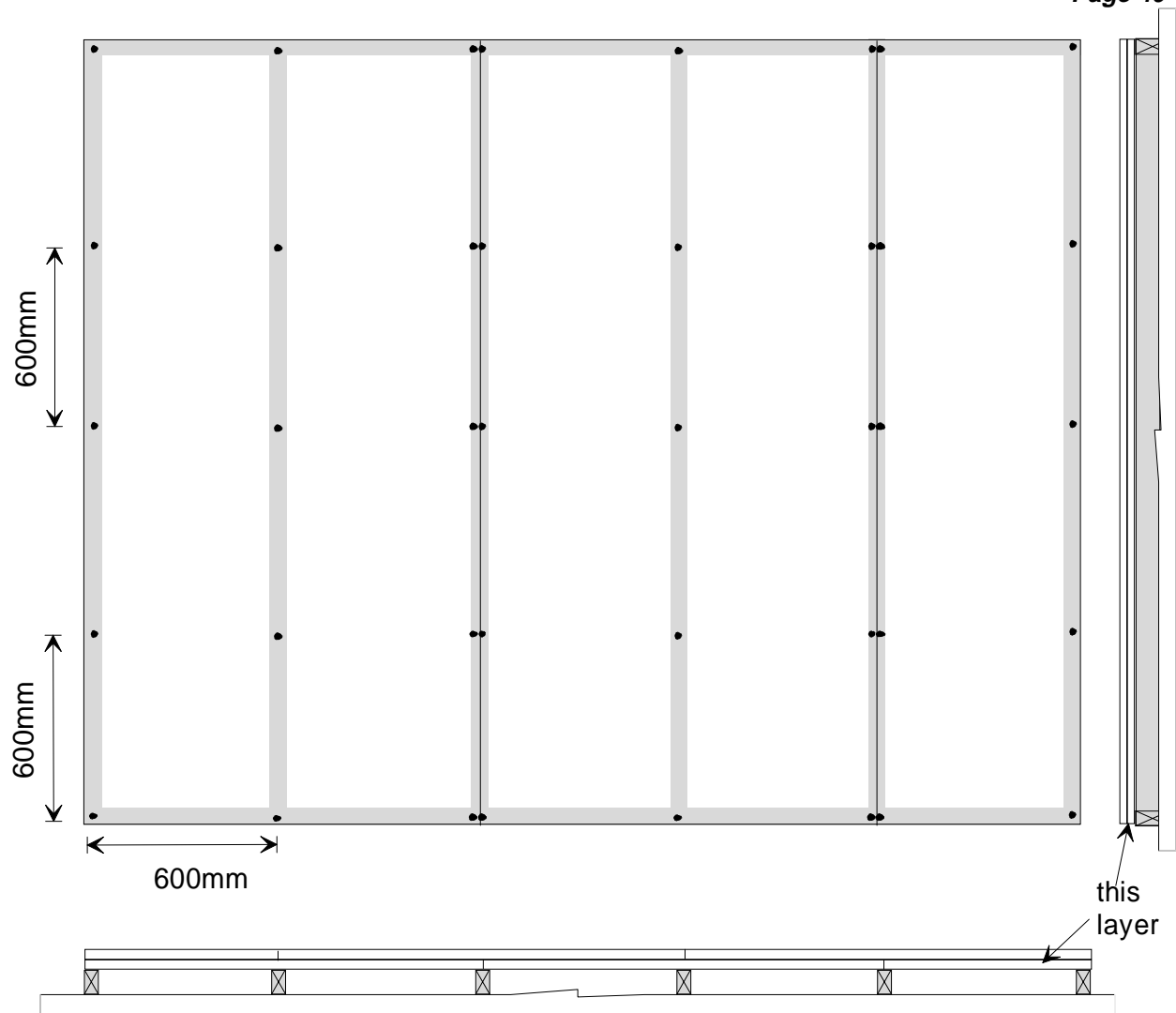

Figure A-2: Base-ply of two-ply gypsum board attached parallel to wood studs at 600 mm o.c., single plates at top and bottom. Meets requirements of CAN/CSA-A82.31-M91, Clause 7.4.3. Drawing not to scale.

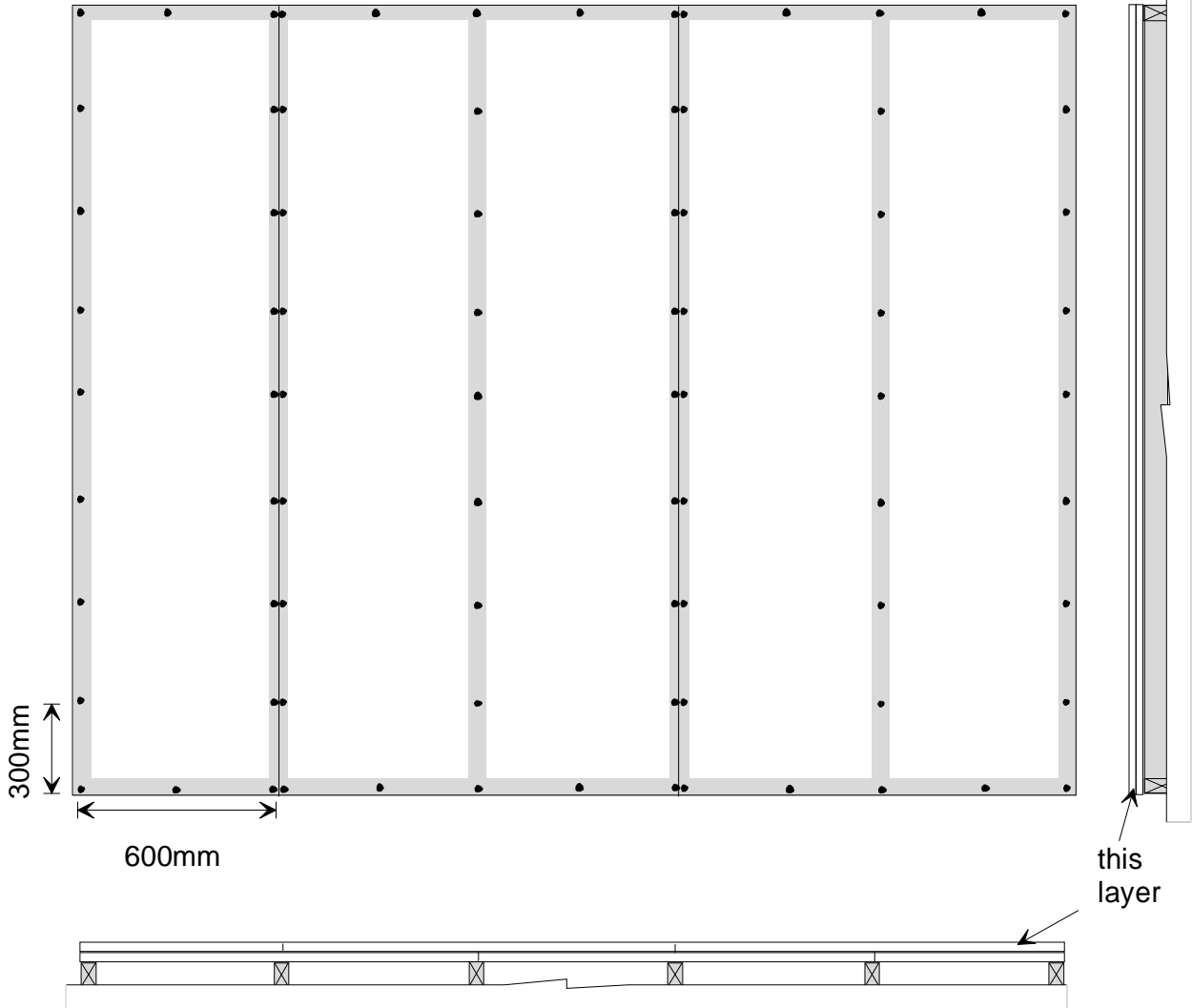

Figure A-3: Face-ply of two-ply gypsum board attached parallel to wood studs at 600 mm o.c., single plates at top and bottom. Meets requirements of CAN/CSA-A82.31-M91, Clause 7.3.4. Drawing not to scale.

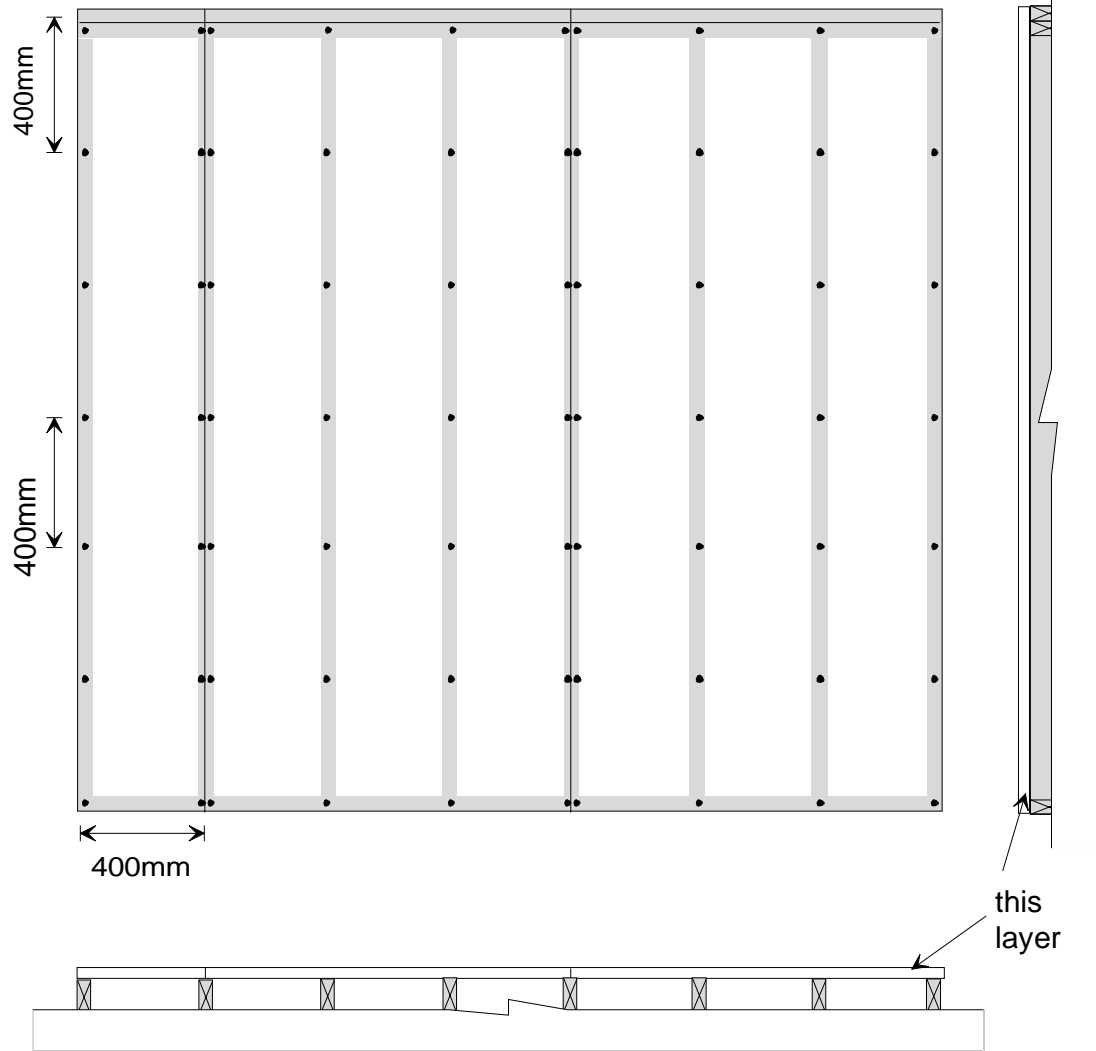

Figure A-4: Single-ply gypsum board attached parallel to wood studs at 400 mm o.c., double plate at top, single plate at bottom. Meets requirements of CAN/CSA-A82.31-M91, Clause 7.3.4, and National Building Code of Canada, Section 9.29.5.9. Drawing not to scale.

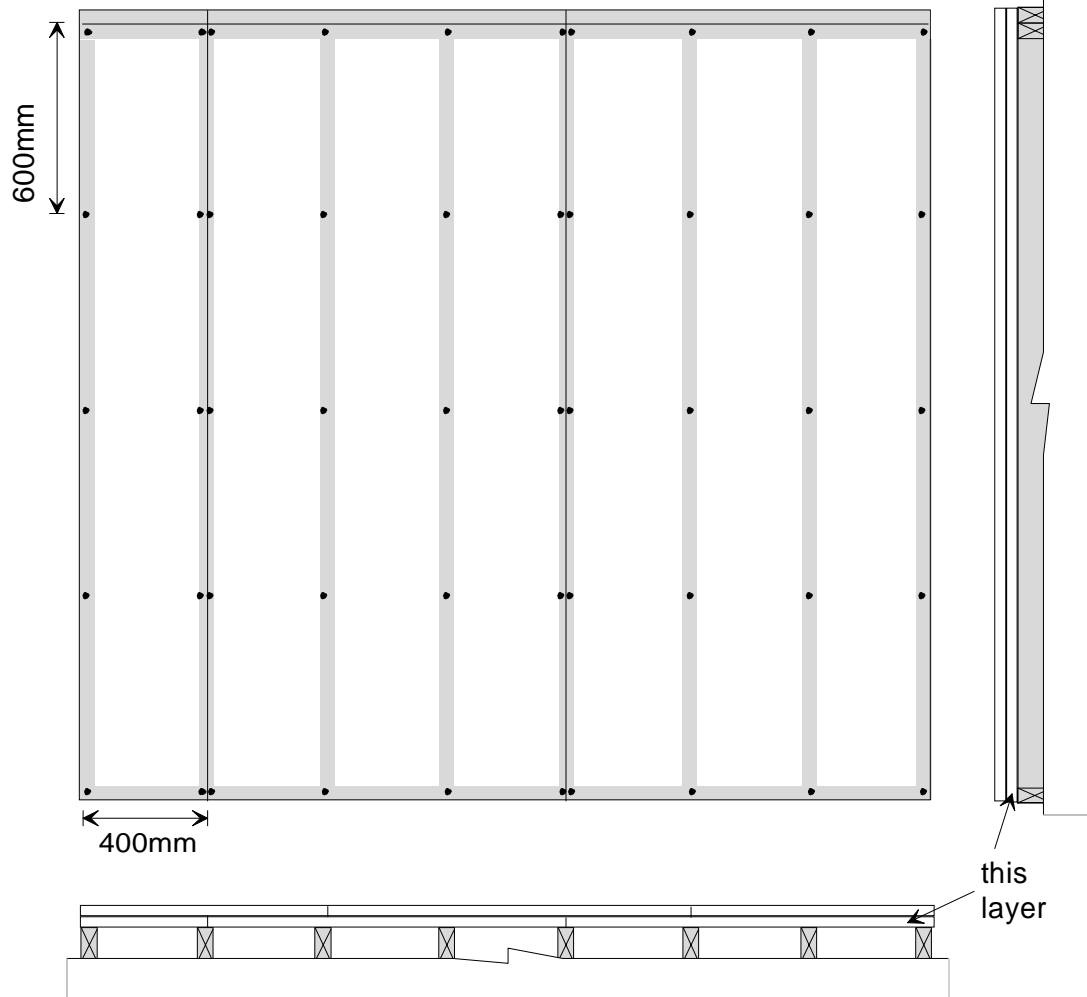

Figure A-5: Base-ply of two-ply gypsum board attached parallel to wood studs at 400 mm o.c., double plate at top, single plate at bottom. Meets requirements of CAN/CSA-A82.31-M91, Clause 7.3.4. Drawing not to scale.

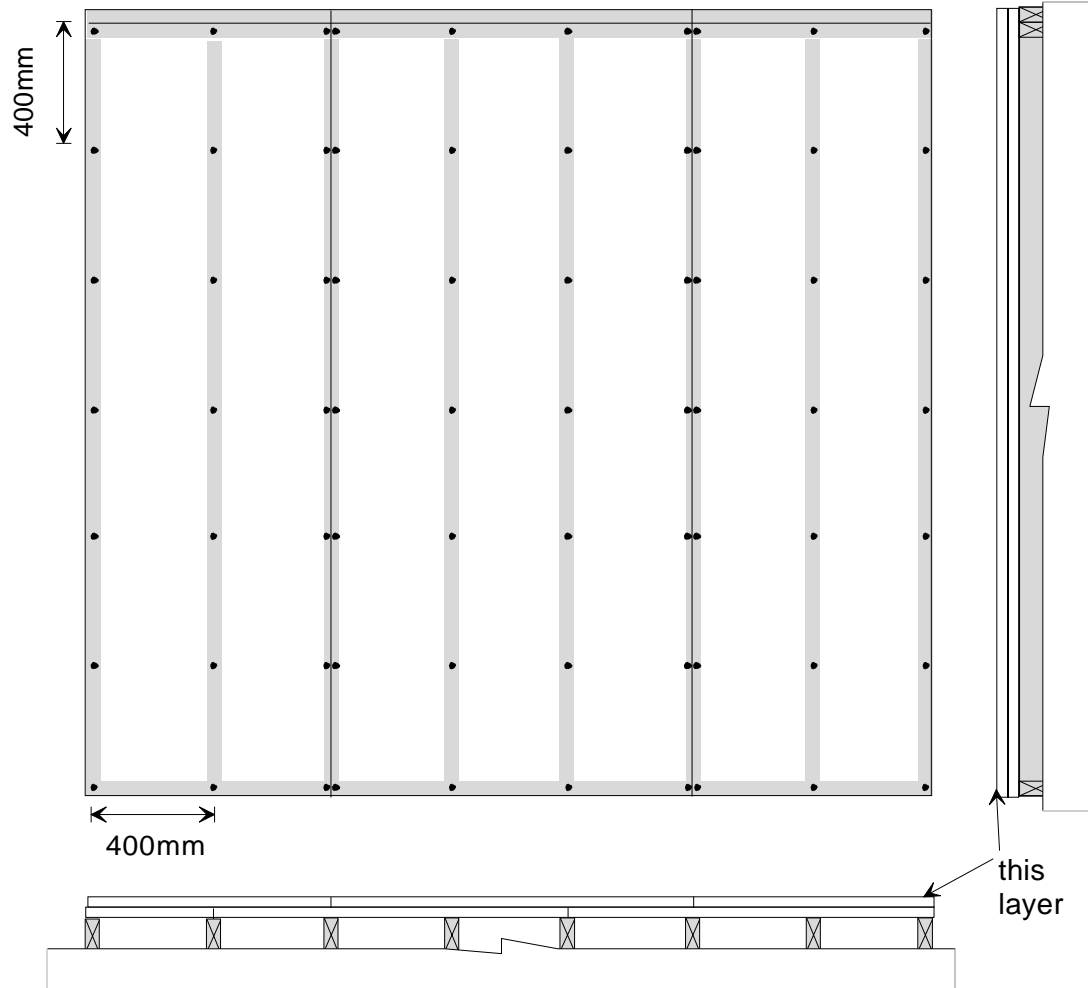

Figure A-6: Face-ply of two-ply gypsum board attached parallel to wood studs at 400 mm o.c., double plate at top, single plate at bottom. Meets requirements of CAN/CSA-A82.31-M91, Clause 7.3.4. Drawing not to scale.

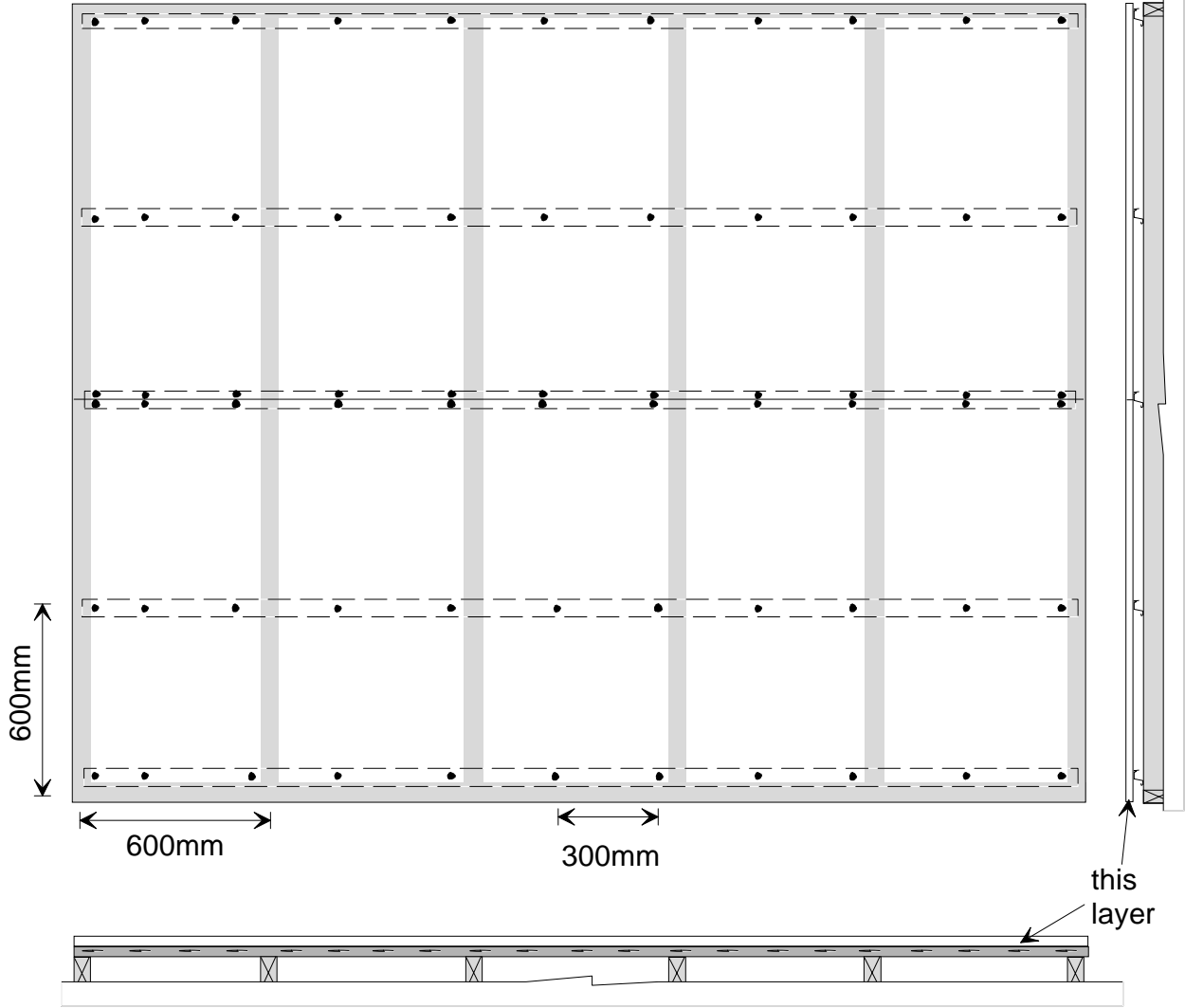

Figure A-7: Single-ply gypsum board attached parallel to resilient furring channels. Resilient channels attached perpendicular to studs at 600 mm o.c.. Wood studs spaced 600 mm o.c., with single plates at top and bottom. Meets requirements of CAN/CSA-A82.31-M91, Clause 12.2.3.1, and National Building Code of Canada, Section 9.29.5.9. Note that screw spacing was shifted from ideal locations to avoid contact with studs. Drawing not to scale.

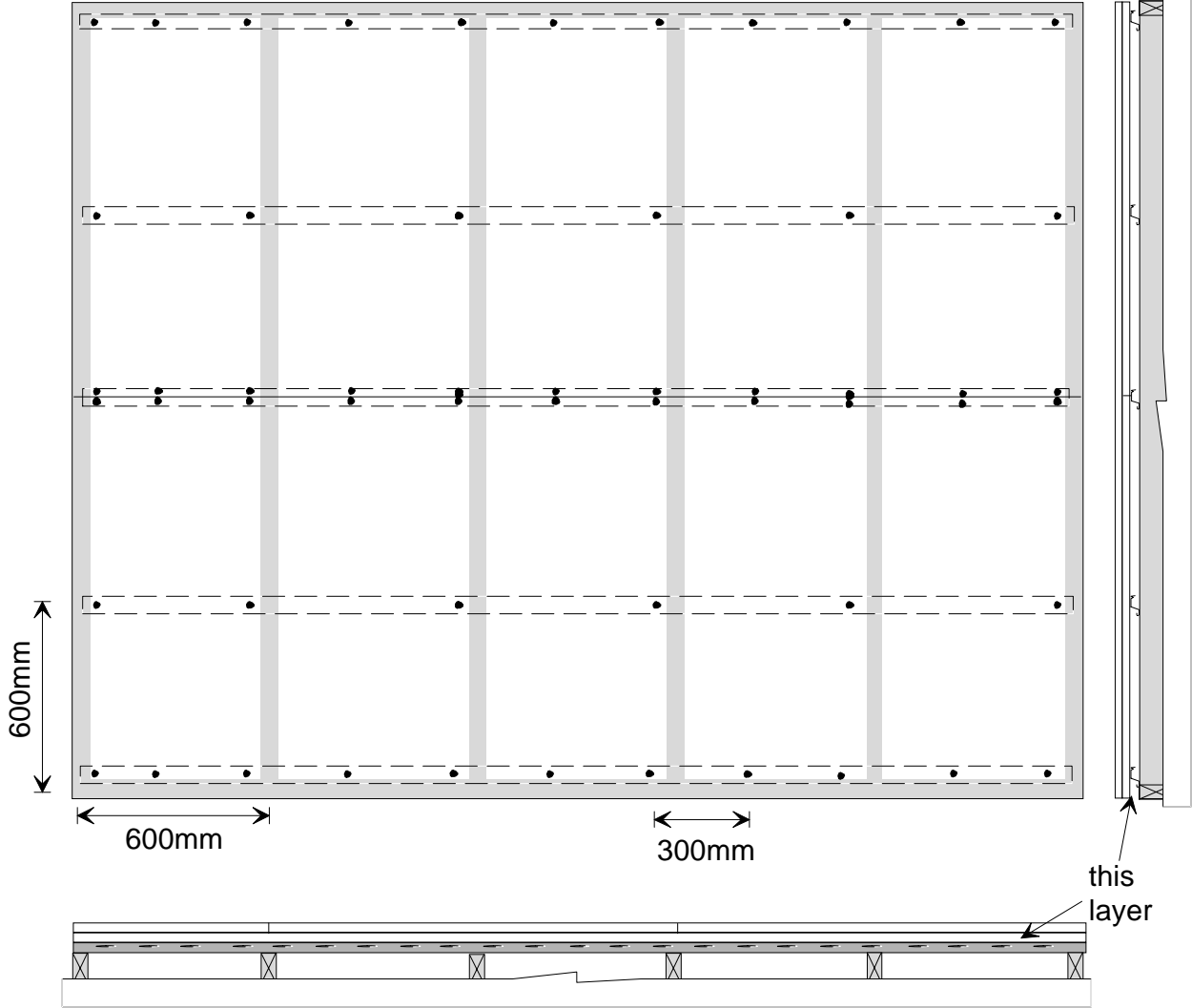

Figure A-8: Base-ply of two-ply gypsum board attached parallel to resilient furring channels. Resilient channels attached perpendicular to studs at 600 mm o.c. Wood studs at 600 mm o.c., with single plates at top and bottom. Meets requirements of CAN/CSA-A82.31-M91, Clause 12.2.3.2. Note that the screw spacing was shifted from ideal locations to avoid contact with studs. Drawing not to scale.

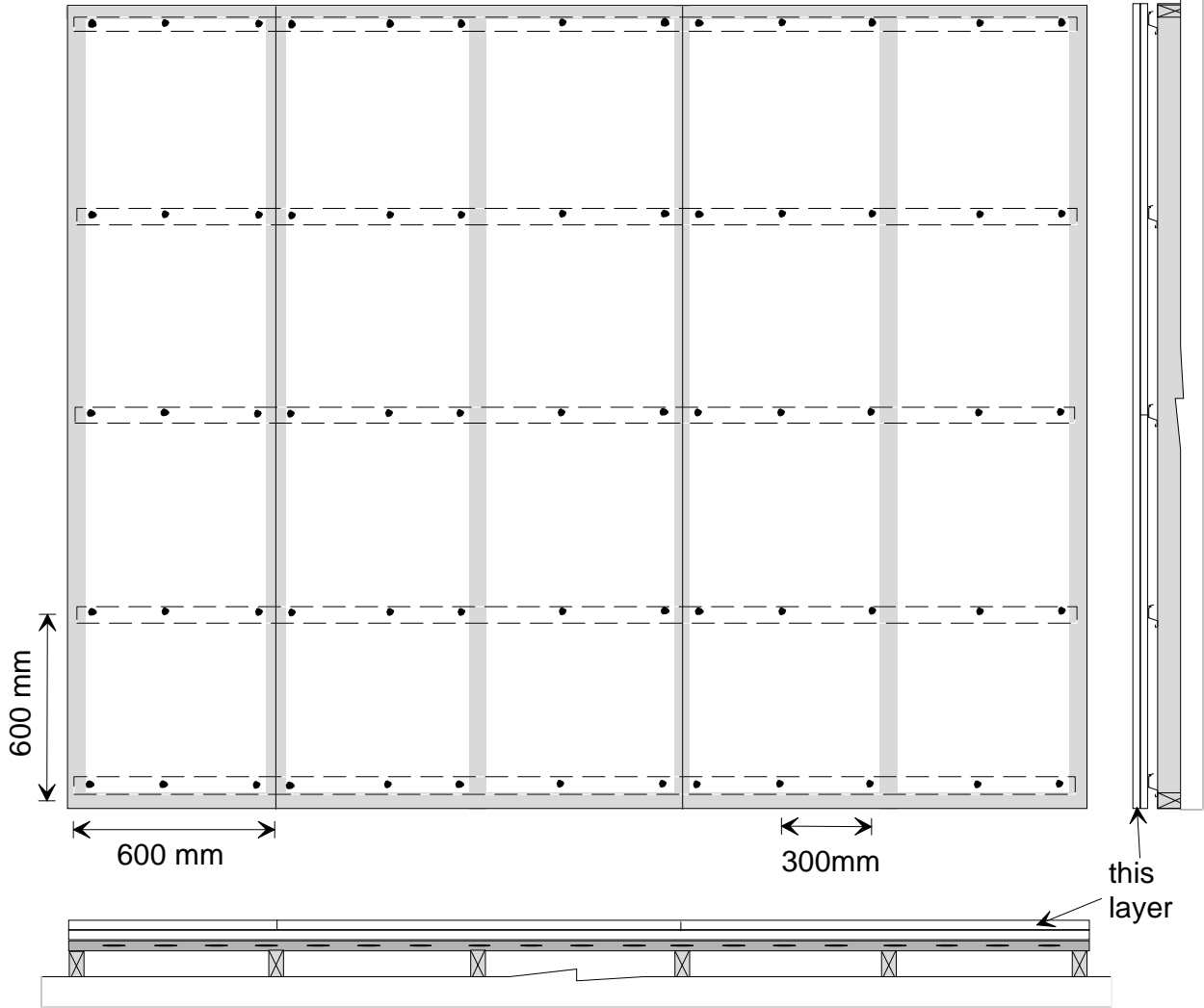

Figure A-9: Face-ply of two-ply gypsum board attached perpendicular to resilient furring channels. Resilient channels attached perpendicular to studs at 600 mm o.c. Wood studs at 600 mm o.c., with single plates at top and bottom. Meets requirements of CAN/CSA-82.31-M91, Clause 12.2.3.1. Note that screw spacing was shifted from ideal locations to avoid contact with studs. Drawing not to scale.

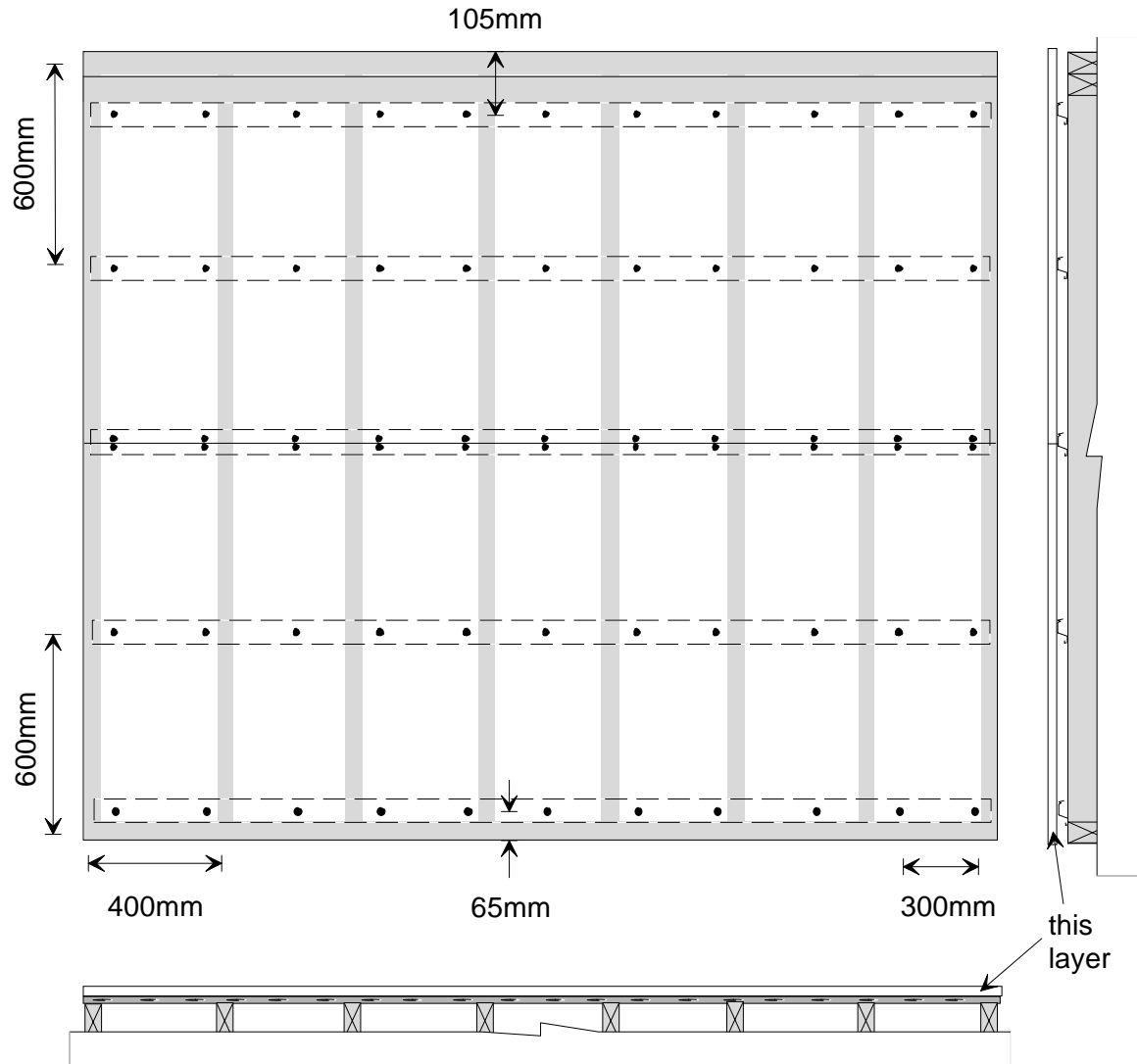

Figure A-10: Single-ply gypsum board attached parallel to resilient furring channels. Studs at 400 mm o.c. Resilient furring channels attached perpendicular to studs at 600 mm o.c.. Note that screw spacing was shifted from ideal locations to avoid contact with studs. Meets requirements of CAN/CSA-A82.31-M91, Clause 12.2.3.1. Drawing not to scale.

Drawing shows wood studs at 400 mm o.c., with double plate at top, single plate at bottom. Same location of resilient channels and screws was used with load-bearing steel studs, except that single track is used at the top, and dimension from top to first row of screws is 70 mm.

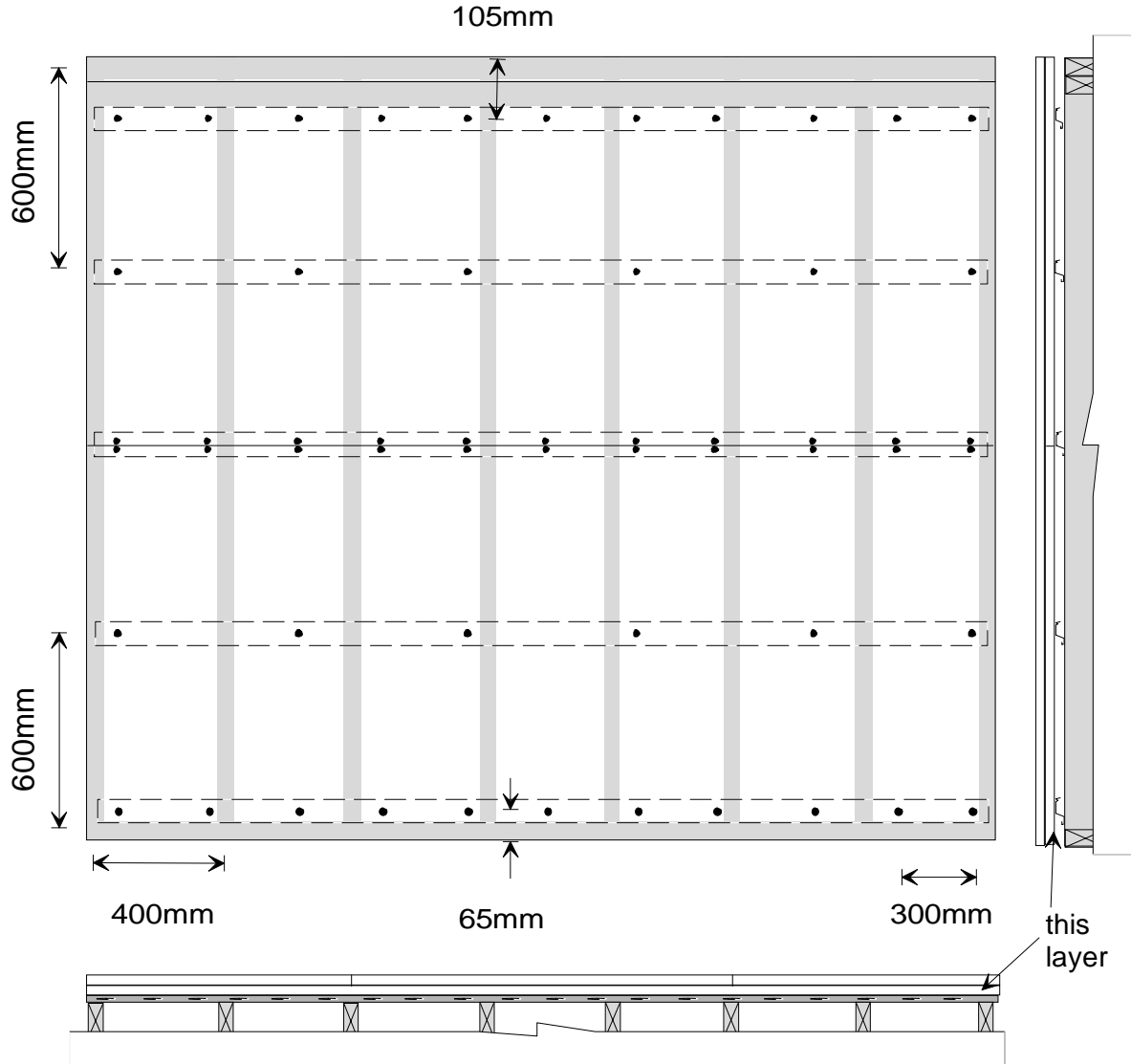

Figure A-11: Base-ply of two-ply gypsum board attached parallel to resilient furring channels. Resilient channels attached perpendicular to studs at 600 mm o.c.. Studs at 400 mm o.c. Meets requirements of CAN/CSA-A82.31-M91, Clause 12.2.3.2. Note that screw spacing was shifted from ideal locations to avoid contact with studs. Drawing not to scale.

Drawing shows wood studs at 400 mm o.c., with double plate at top, single plate at bottom. Same location of resilient furring channels and screws is used with load-bearing steel studs, except that single track is used at the top, and dimension from top to first row of screws is 70 mm.

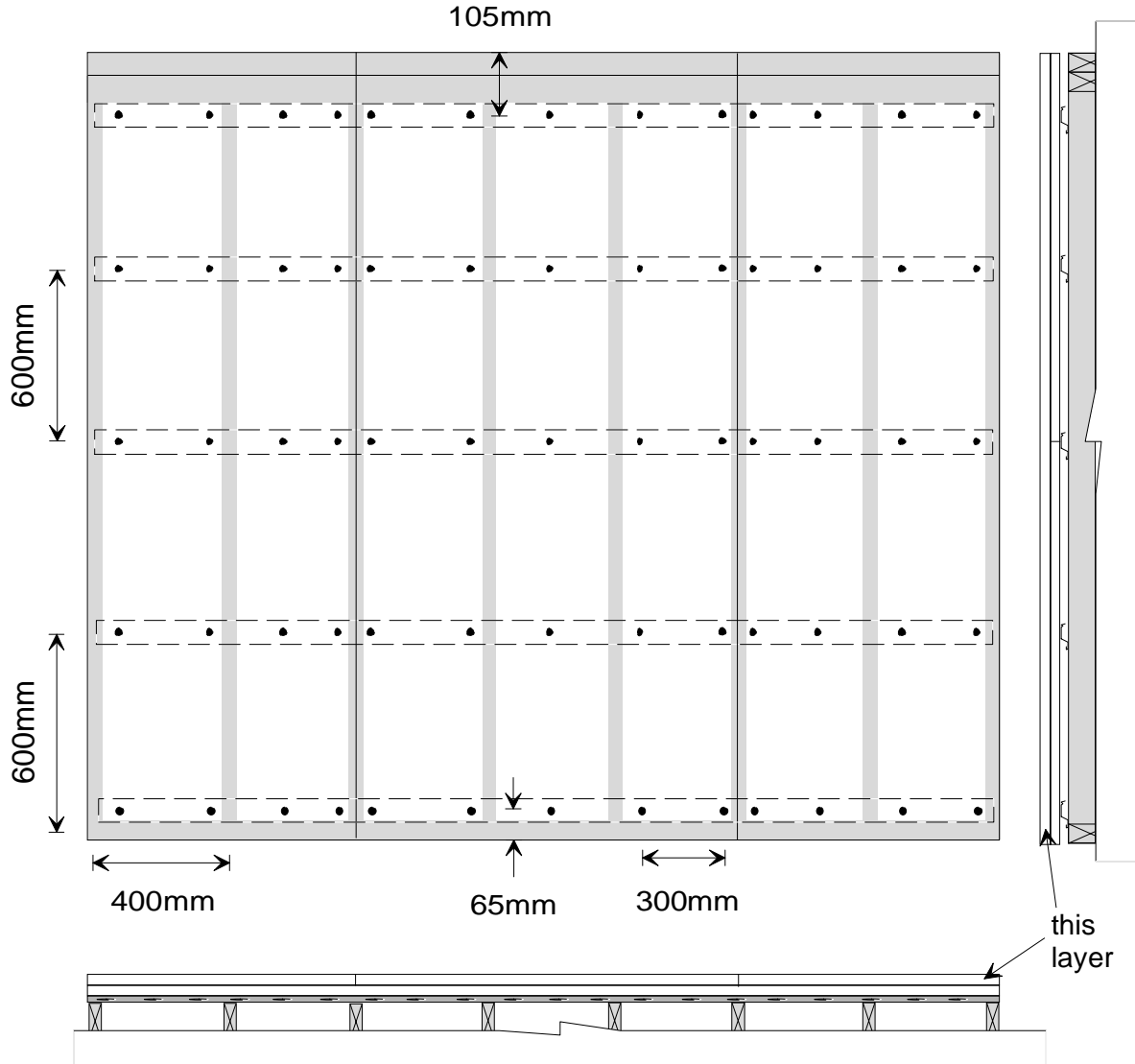

Figure A-12: Face-ply of two-ply gypsum board attached perpendicular to resilient furring channels. Resilient channels attached perpendicular to studs at 600 mm o.c.. Studs at 400 mm o.c.. Meets requirements of CAN/CSA-A82.31-M91, Clause 12.2.3.1. Note that screw spacing was shifted from ideal locations to avoid contact with studs. Drawing not to scale.

Drawing shows wood studs at 400 mm o.c., with double plate at top, and single plate at bottom. Same location of resilient furring channels and screws was used with load-bearing steel studs, except that single track is used at the top, and dimension from top to first row of screws is 70 mm.

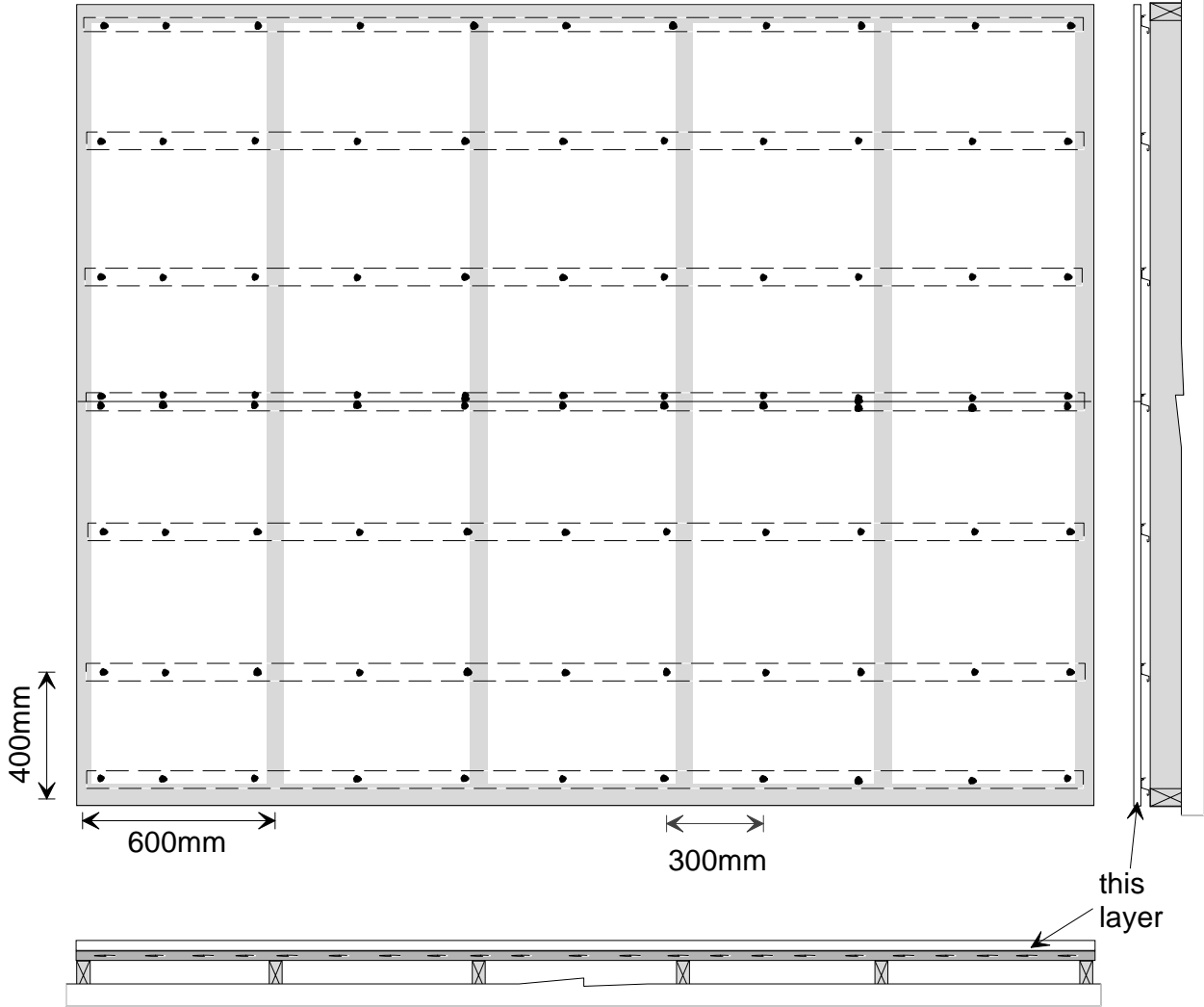

Figure A-13: Single-ply gypsum board attached parallel to resilient furring channels. Resilient channels attached perpendicular to studs at 400 mm o.c.. Studs at 600 mm o.c., single plates at top and bottom. Meets requirements of CAN/CSA-82.31-M91, Clause 12.2.3.1, and National Building Code of Canada, Section 9.29.5.9. Note that screw spacing was shifted from ideal locations to avoid contact with studs. Drawing not to scale.

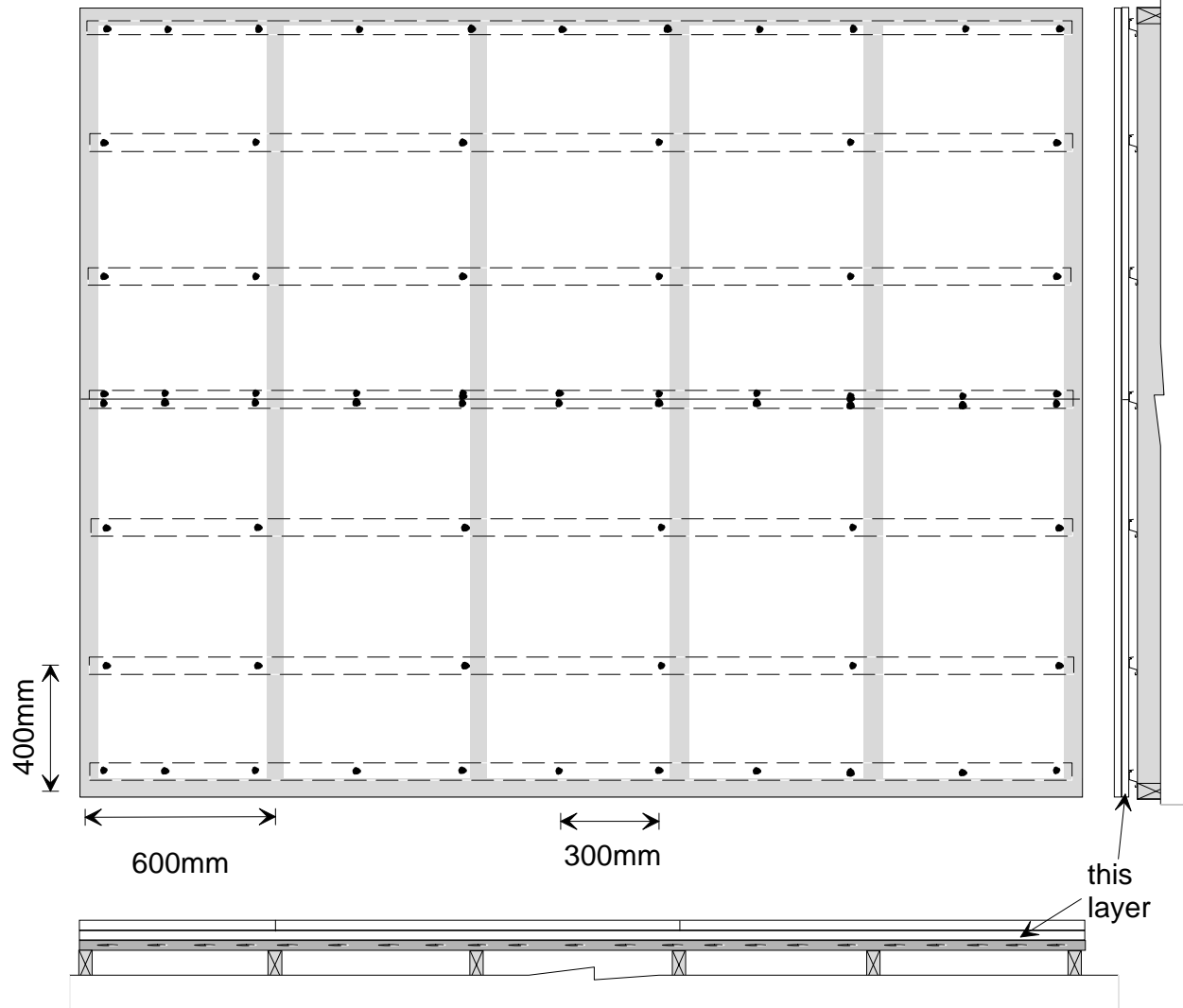

Figure A-14: Base-ply of two-ply gypsum board attached parallel to resilient furring channels. Resilient channels attached perpendicular to studs at 400 mm o.c.. Studs at 600 mm o.c., single plates at top and bottom. Meets requirements of CAN/CSA-A82.31-M91, Clause 12.2.3.2. Note that screw spacing was shifted from ideal locations to avoid contact with studs. Drawing not to scale.

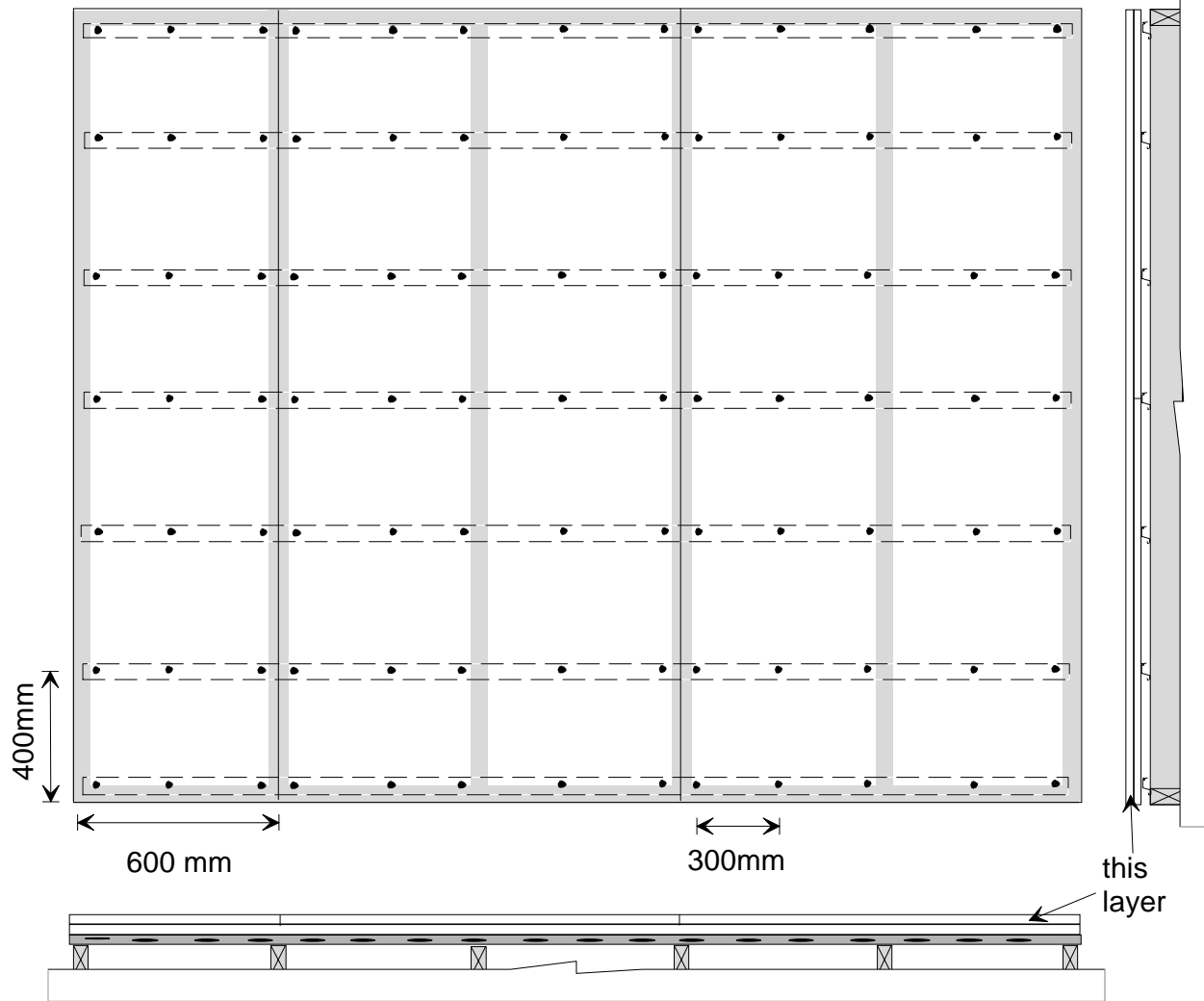

Figure A-15: Face-ply of two-ply gypsum board attached perpendicular to resilient furring channels. Resilient channels attached perpendicular to studs at 400 mm o.c.. Studs at 600 mm o.c., single plates at top and bottom. Meets requirements of CAN/CSA-A82.31-M91, Clause 12.2.3.1. Note that screw spacing was shifted from ideal locations to avoid contact with studs. Drawing not to scale.

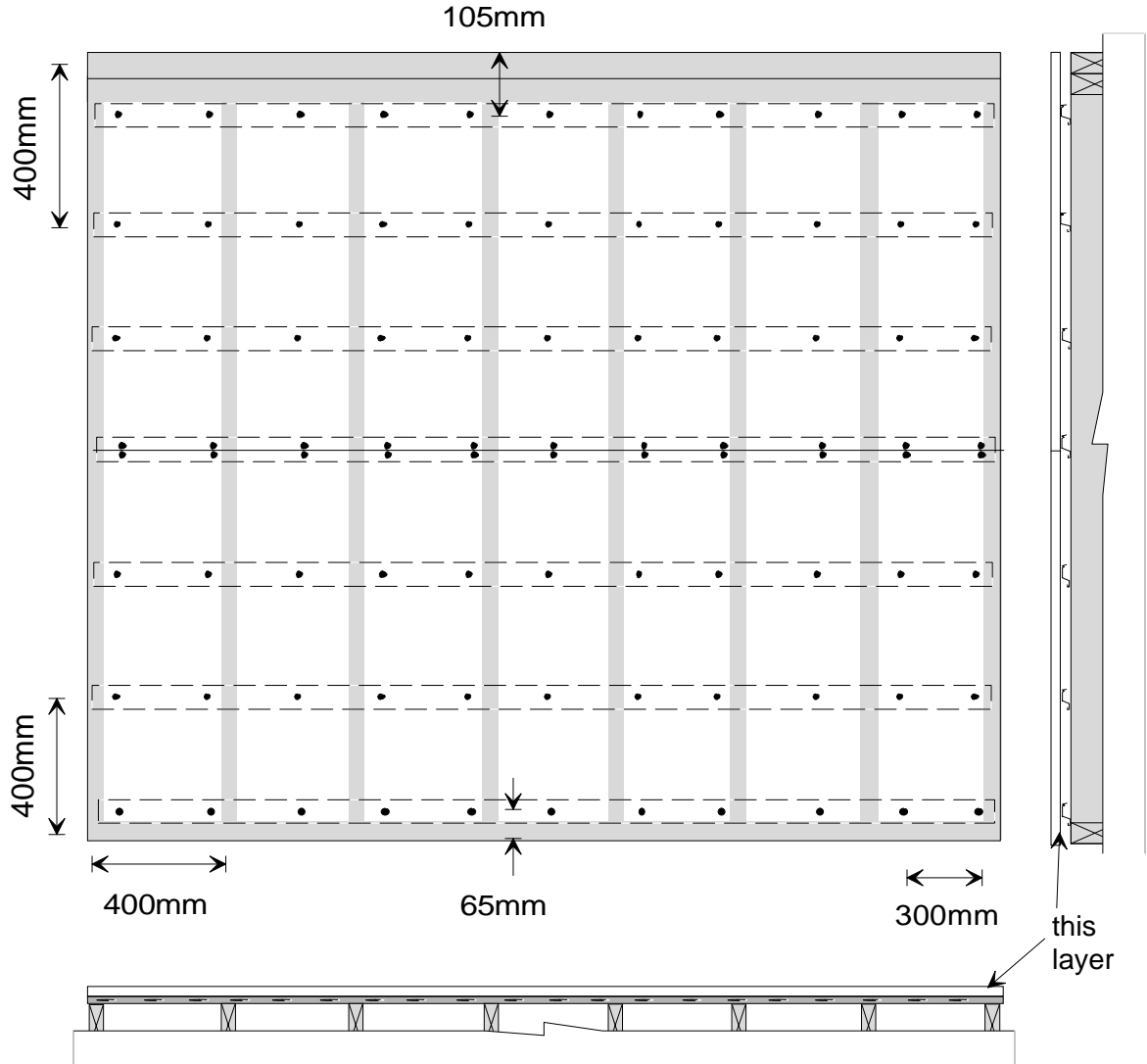

Figure A-16: Single-ply gypsum board attached parallel to resilient furring channels. Resilient channels attached perpendicular to studs at 400 mm o.c.. Studs at 400 mm o.c., double plate at top, single plate at bottom. Meets requirements of CAN/CSA-A82.31-M91, Clause 12.2.3.1. Note that screw spacing was shifted from ideal locations to avoid contact with studs. Drawing not to scale.

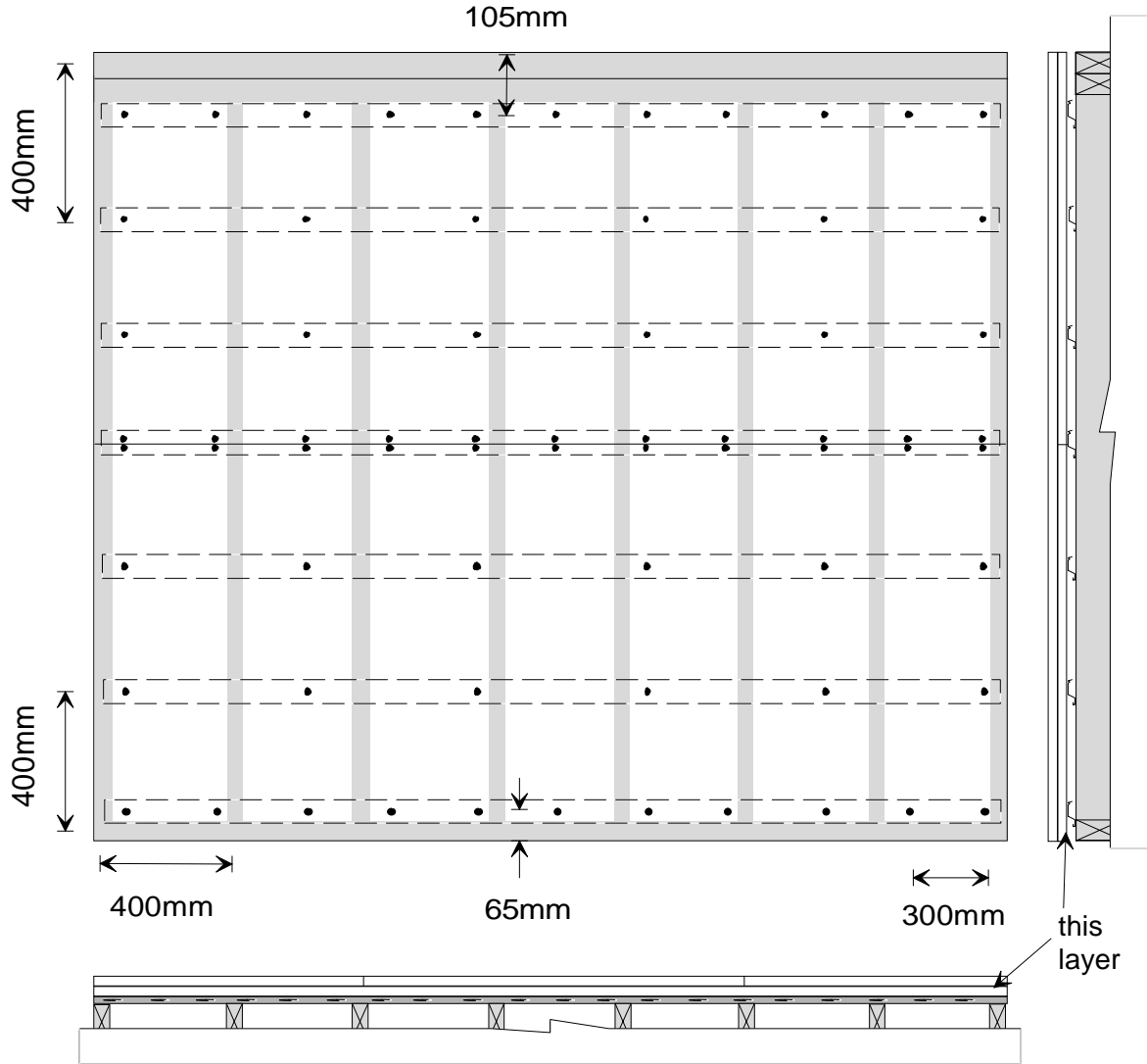

Figure A-17: Base-ply of two-ply gypsum board attached parallel to resilient furring channels. Resilient channels attached perpendicular to studs at 400 mm o.c.. Studs at 400 mm o.c., double plate at top, single plate at bottom. Meets requirements of CAN/CSA-A82.31-M91, Clause 12.2.3.2. Note that screw spacing was shifted from ideal locations to avoid contact with studs. Drawing not to scale.

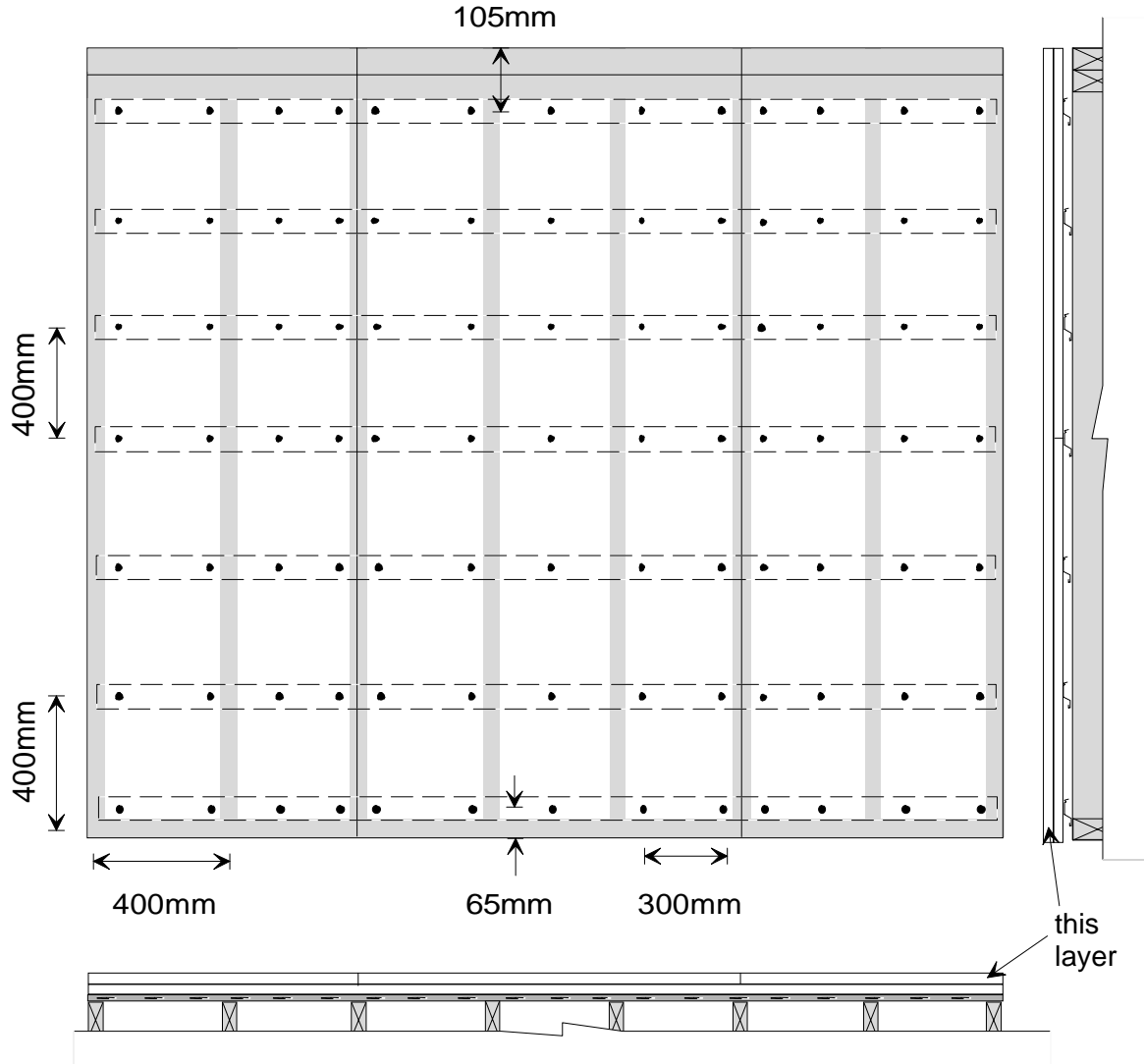

Figure A-18: Face-ply of two-ply gypsum board attached perpendicular to resilient furring channels. Resilient channels attached perpendicular to studs at 400 mm o.c.. Studs at 400 mm o.c., double plate at top, single plate at bottom. Meets requirements of CAN/CSA-A82.31-M91, Clause 12.2.3.1. Note that screw spacing was shifted from ideal locations to avoid contact with studs. Drawing not to scale.

Screw pattern in top header
either (a) or (b) as shown

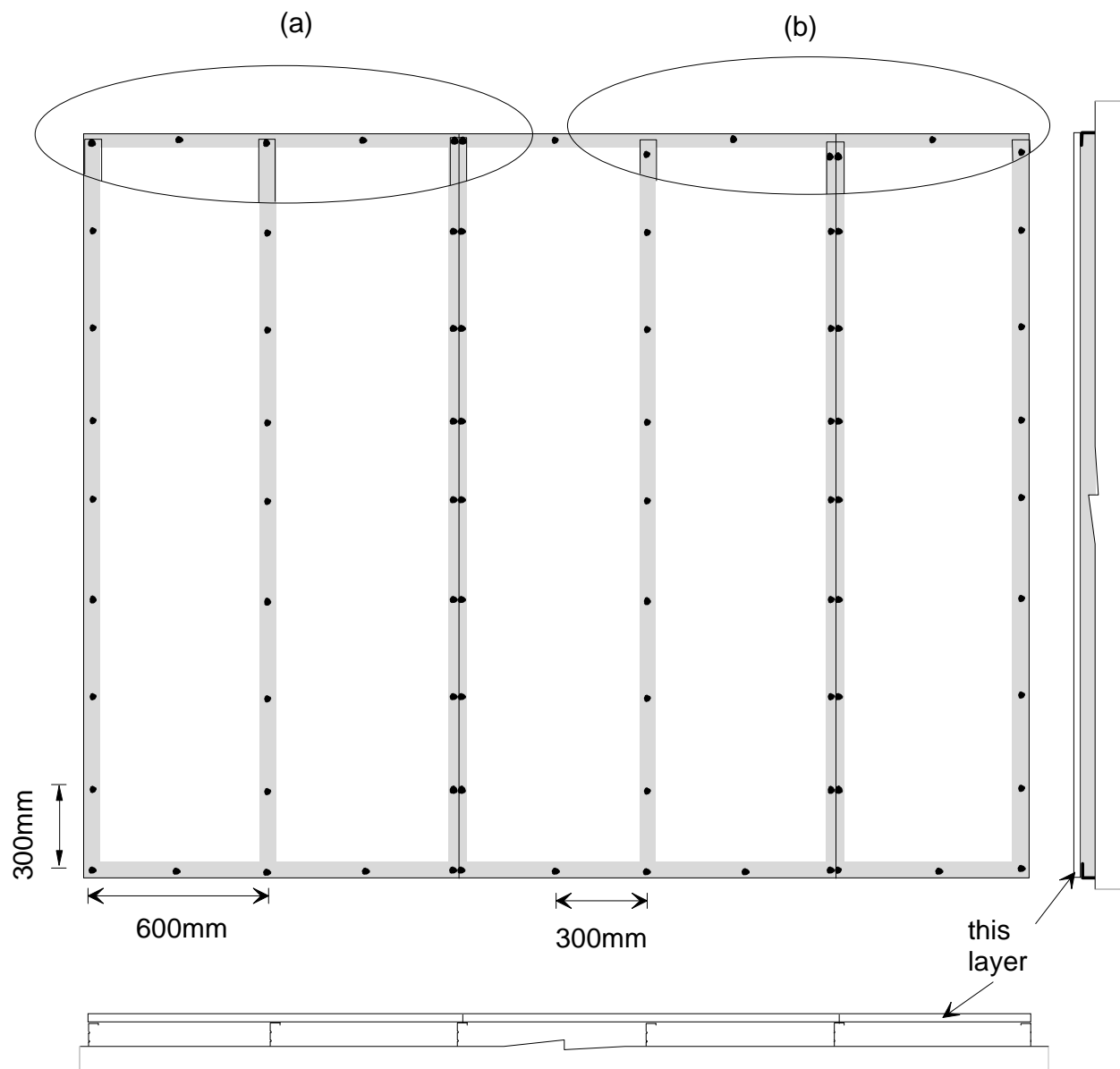

Figure A-19: Single-ply gypsum board attached parallel to non-loadbearing steel studs at 600 mm o.c., single tracks at top and bottom. Pattern (a) and (b) meet requirements of CAN/CSA-A82.31-M91, Clause 12.2.3.1, and National Building Code of Canada, Section 9.29.5.9. Pattern (b) is required for fire resistance (Clause 18.2.6 of CAN/CSA-A82.31-M91 and National Building Code of Canada, Section 9.24.3.2).

As discussed in text, sound transmission did not change significantly between pattern (a) and (b) in controlled comparisons. Drawing not to scale.

Screw pattern in top header either (a) or (b) as shown

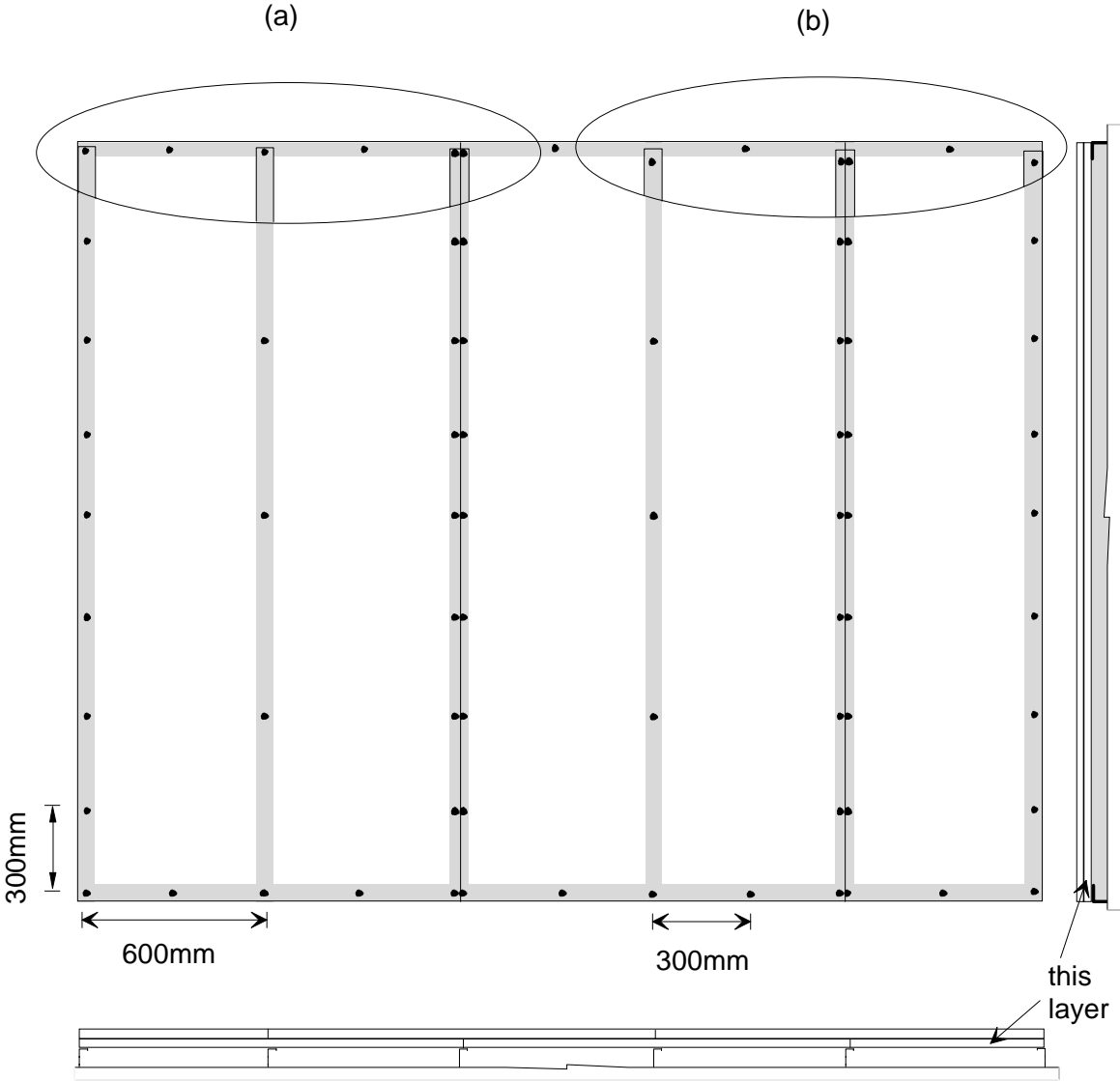

Figure A-20: Base-ply of two-ply gypsum board attached parallel to steel studs at 600 mm o.c., single tracks at top and bottom. Meets requirements of CAN/CSA-A82.31-M91, Clause 12.2.3.2. Pattern (b) is required for fire resistance (Clause 18.2.6 of CAN/CSA-A82.31-M91 and National Building Code of Canada, Section 9.24.3.2).

As discussed in text, sound transmission did not change significantly between pattern (a) and (b) in controlled comparisons. Drawing not to scale.

Screw pattern in top header
either (a) or (b) as shown

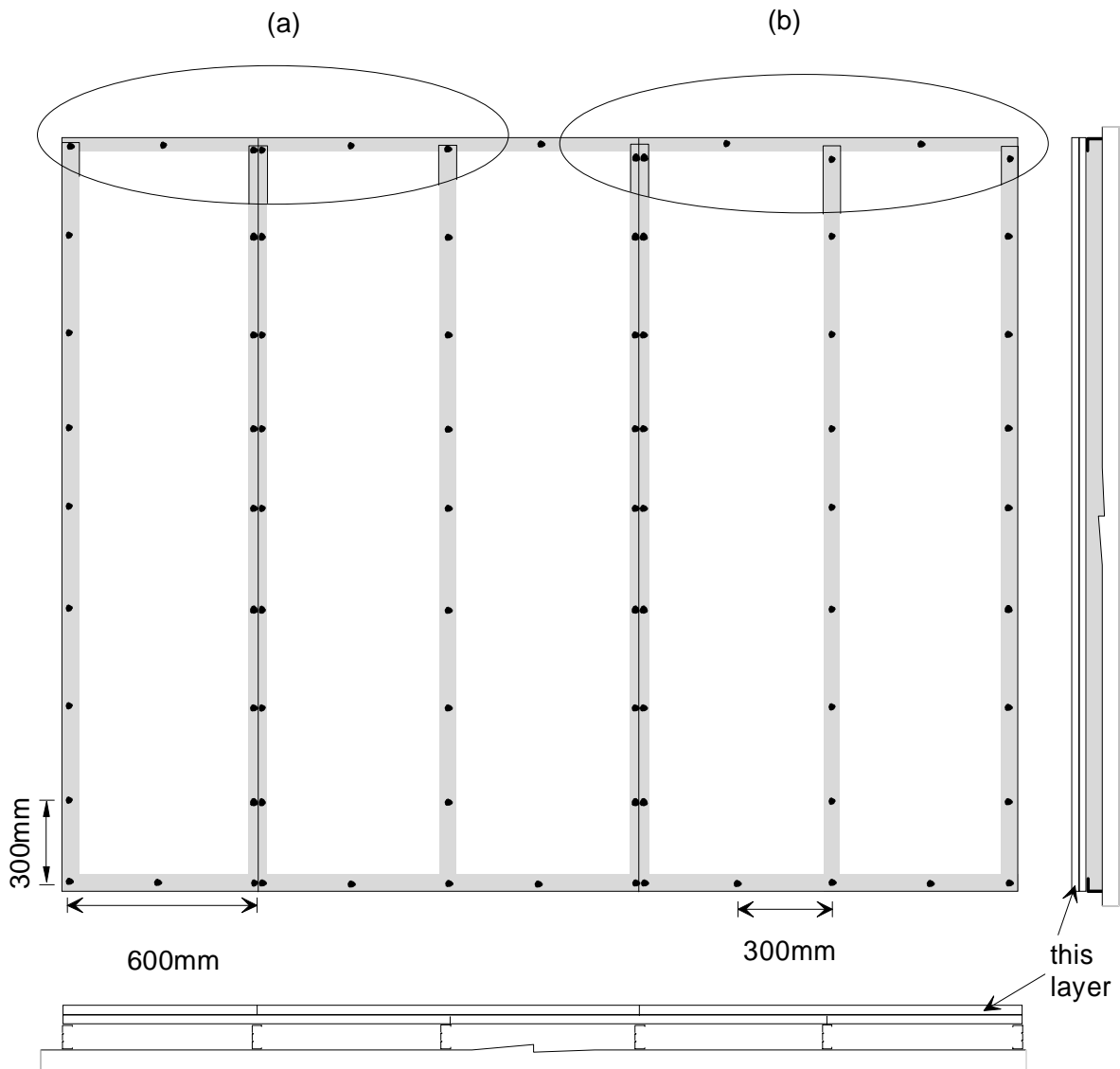

Figure A-21: Face-ply of two-ply gypsum board attached parallel to steel studs at 600 mm o.c., single tracks at top and bottom. Meets requirements of CAN/CSA-A82.31-M91, Clause 12.2.3.1. Pattern (b) is required for fire resistance (Clause 18.2.6 of CAN/CSA-A82.31-M91 and National Building Code of Canada, Section 9.24.3.2).

As discussed in text, sound transmission did not change significantly between pattern (a) and (b) in controlled comparisons. Drawing not to scale.

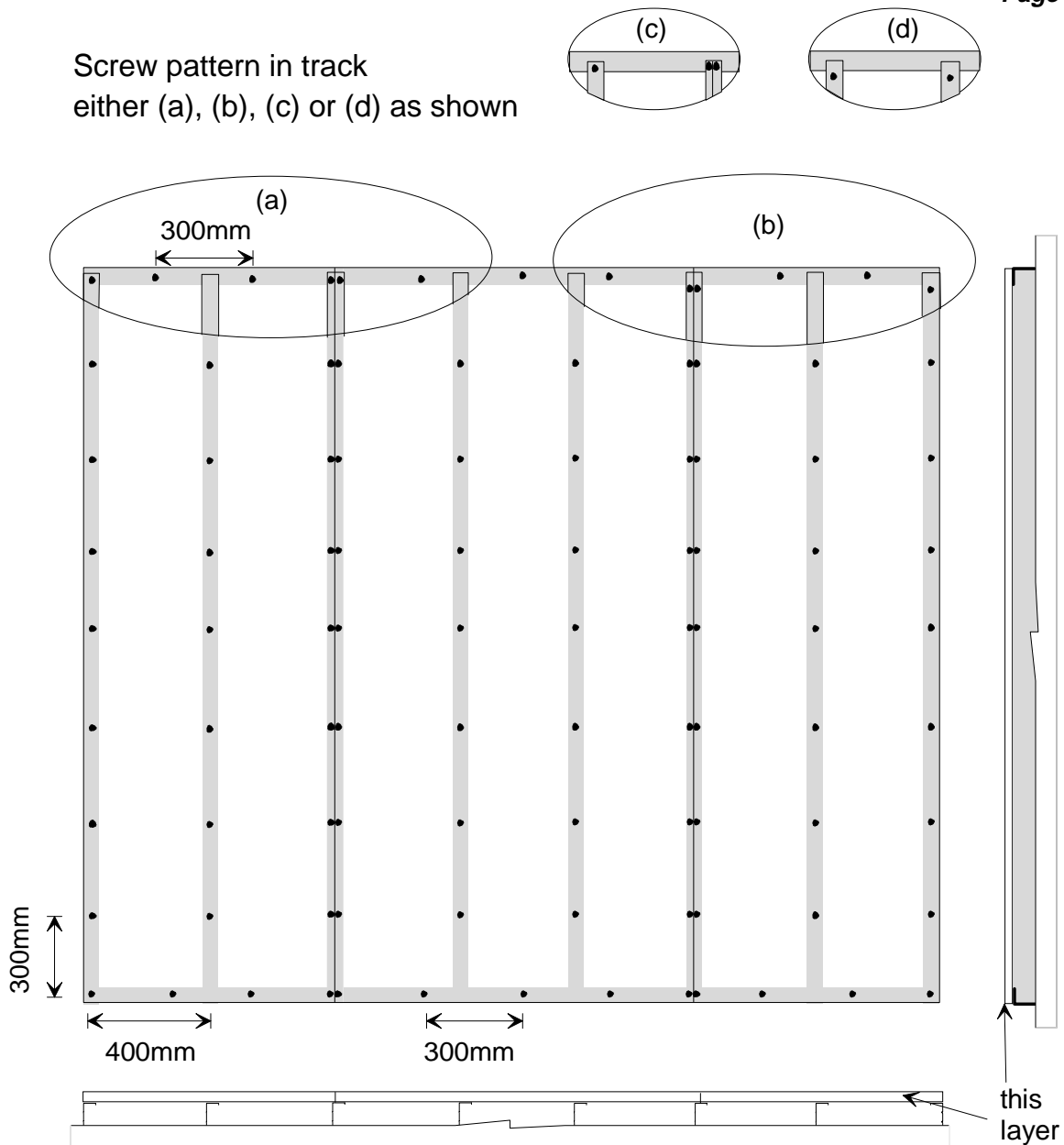

Figure A-22: Single-ply gypsum board attached parallel to steel studs at 400 mm o.c., single tracks at top and bottom. Pattern (a) and (b) meet requirements of CAN/CSA-A82.31-M91, Clause 12.2.3.1, and National Building Code of Canada, Section 9.29.5.9. Drawing not to scale.

For load-bearing steel studs, pattern (a) was used.

For non-loadbearing steel studs, pattern (b) is required for fire resistance (Clause 18.2.6 of CAN/CSA-A82.31-M91 and National Building Code of Canada, Section 9.24.3.2) and studs are not attached to top track. Some specimens were also tested with patterns (c) and (d) as discussed in text.

Screw pattern in track
either (a), (b), (c) or (d) as shown

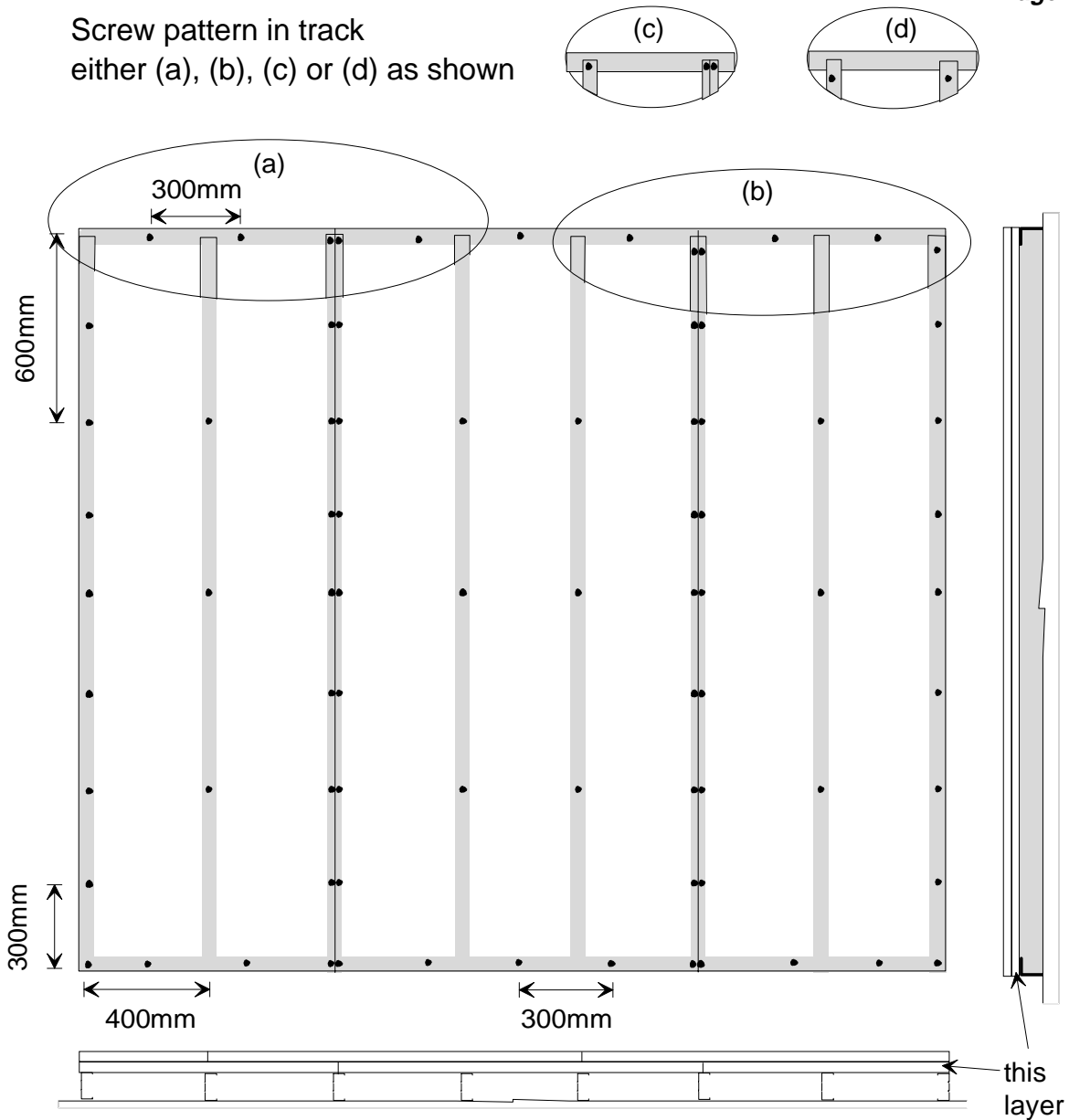

Figure A-23: Base-ply of two-ply gypsum board attached parallel to steel studs at 400 mm o.c., single tracks at top and bottom.. Pattern (a) and (b) meet requirements of CAN/CSA-A82.31-M91, Clause 12.2.3.1, and National Building Code of Canada, Section 9.29.5.9. Drawing not to scale.

For load-bearing steel studs, pattern (a) was used.

For non-loadbearing steel studs, pattern (b) is required for fire resistance (Clause 18.2.6 of CAN/CSA-A82.31-M91 and National Building Code of Canada, Section 9.24.3.2) and studs are not attached to top track. Some specimens were also tested with patterns (c) and (d) as discussed in text.

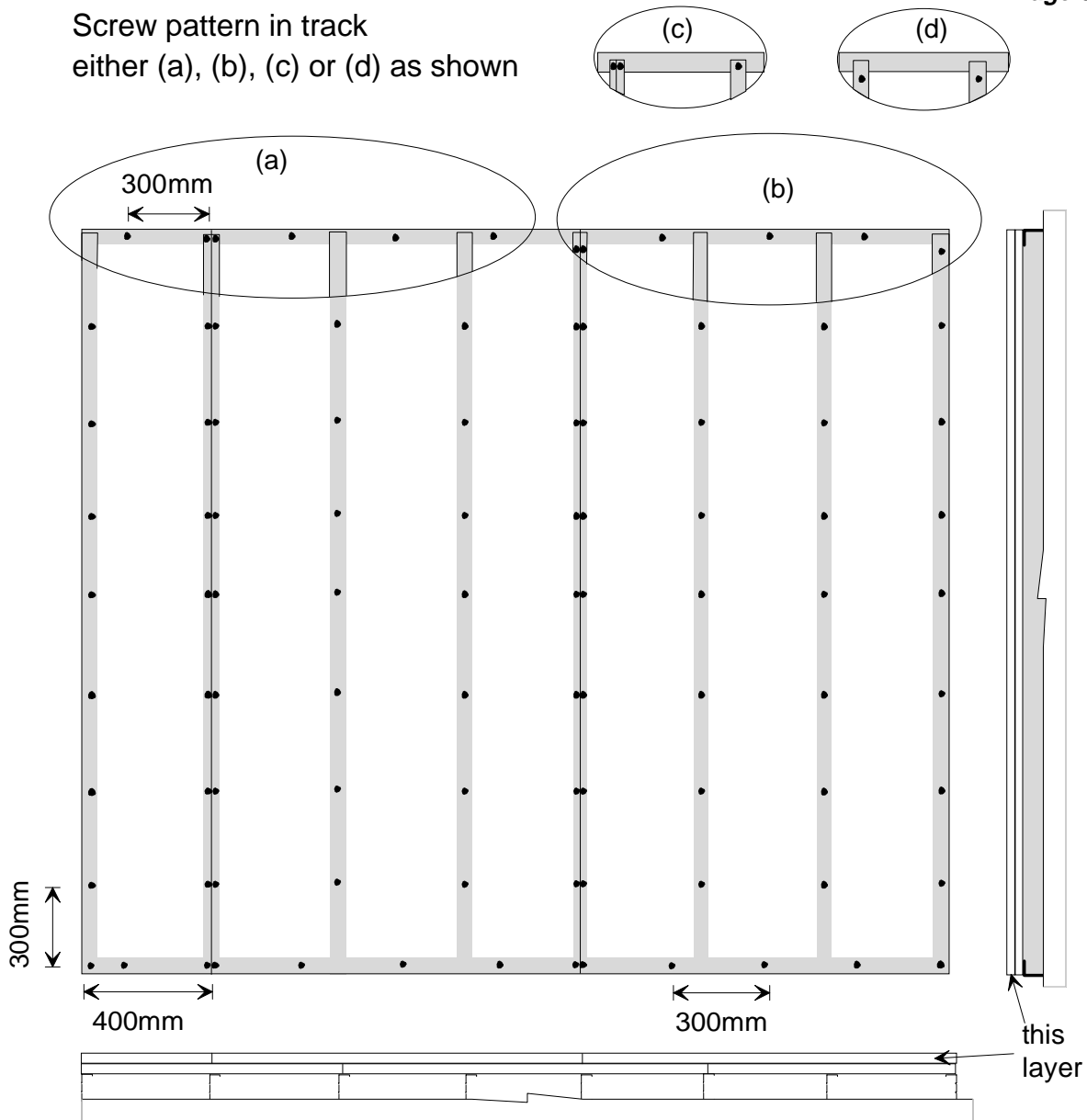

Figure A-24: Face-ply of two-ply gypsum board attached parallel to steel studs at 400 mm o.c., single tracks at top and bottom. Meets requirements of CAN/CSA-A82.31, Clause 12.2.3.1. Drawing not to scale.

For load-bearing steel studs, pattern (a) was used.

For non-loadbearing steel studs, pattern (b) is required for fire resistance (Clause 18.2.6 of CAN/CSA-A82.31-M91 and National Building Code of Canada, Section 9.24.3.2) and studs are not attached to top track. Some specimens were also tested with patterns (c) and (d) as discussed in text.

This Appendix combines results from the IRC/NRCC laboratory with material evaluations performed by D.M. Onysko and J.C. Garrant of the FORINTEK laboratory. (The evaluation of the gypsum board and the wood framing were the responsibility of FORINTEK.)

ABSORPTIVE MATERIAL

The weight of absorptive material was recorded for each specimen tested. These values were used to calculate the average weight per unit area, and dividing this by nominal absorption thickness gave the density. For wet-sprayed cellulose fibre, the actual thickness was sampled at many positions to determine the effective thickness. For blown-in cellulose fibre, the thickness was taken to be the distance across the cavity.

Airflow resistance was measured according to ASTM C522-87 for samples of each type of absorptive material (square samples 150 x 150 mm). For airflow measurement of loose fill cellulose fibre material, the material was compressed in the specimen holder to approximately the same density obtained when it was blown into the wall cavities. Several tests with different compression showed the airflow resistivity was quite sensitive to density of the sample. This value should therefore be recognized as rather uncertain; significant changes might occur for the range of densities observed in wall specimens. Specimens of wet-spray cellulose fibre material gave quite similar results. Data are listed in Table B-1.

Table B-1: Density and airflow resistivity for samples of absorptive material.

		Density (kg/m ³)		Airflow Resistivity (mks rayls/m)	
		Average Value	Standard Deviation	Average Value	Standard Deviation
glass fibre (G1)	89 mm batt	12.2	0.4	4800	400
glass fibre (G1)	65 mm batt	11.7	1.0	3600	200
glass fibre (G1)	150 mm batt	11.2	0.0	4300	700
glass fibre (G2)	89 mm batt	16.4	0.6	7900	400
mineral fibre (M1)	89 mm batt	32.6	2.1	12700	2300
mineral fibre (M1)	65 mm batt	36.7	2.1	11400	1700
mineral fibre (M2)	75 mm batt	44.2	1.7	16600	900
mineral fibre (M2)	40 mm batt	51.9	2.2	15000	500
mineral fibre (M3)	83 mm batt	98.1	1.3	58800	5200
cellulose (C1)	wet spray	56.3	10.2	N/A	N/A
cellulose (C2)	90 mm blown	49.3	6.0	33000	

Vibration transfer through the cavity absorption material - which depends on its compressive stiffness - is also an issue of concern. Although a dynamic stiffness test has been developed for materials used under floating floors (ISO 9052-1), this method

applies to specimens compressed under a standard weight. Unfortunately, the stiffness for fibrous absorptive material is expected to depend on compression, and ISO 9052-1 will tend to provide different compression from that occurring when material is placed in a cavity of specific depth. A static test for measuring compressive properties of thermal insulations (ASTM C165) does exist, and in principle the slope of the load/deformation curve should give the dynamic stiffness. A modification of this method with the specimen restrained in a cavity is being used; this modification is needed to deal with the blown-in cellulose material. Results will be given in a subsequent IRC/NRCC report.

WOOD STUDS

Weights were recorded for the studs in each wall specimen. The weight per metre varied only slightly, as shown by the statistics in Table B-2. Moisture content was measured by FORINTEK for each stud; statistics on these values for each wood-frame assembly are also given in Table B-2. The moisture content was also monitored periodically over the time each specimen was in place in the acoustics test chambers; variations were less than 1% moisture content in all cases.

The instrument used for measurement of moisture content of wood was a resistance type Delmhorst RMD-1 meter. The meter used at the IRC/NRCC laboratory (borrowed from FORINTEK) is from the same family. All have been calibrated in the factory for use on Douglas-fir material. The RMD-1 meter is digital and had the species correction factors built into it. The species correction factors are those determined at the Eastern and Western Laboratories of FORINTEK, from research on this topic over the last 30 years.

The ASTM standard on use of hand-held moisture meters forms the basis for most of this work except that some latitude was taken. The wood studs were conditioned in the FORINTEK laboratories over a relatively long time and the gradients in moisture were low. Consequently, in these circumstances, an estimate of bulk moisture content based on moisture meter readings can be obtained using a relatively small number of readings per specimen. However, a full complement of readings was taken (numbering six per specimen) just prior to transfer of the material to IRC/NRCC for assembly as a wall.

Table B-2: Mass and moisture content of 38x89 mm wood studs.

Test Number	Mass per Unit Length (kg/m)		Moisture Content (%)	
	Average Value	Standard Deviation	Average Value	Standard Deviation
TL-93-082 to TL-93-104 (inclusive)	1.39	0.19	7.5	0.8
TL-93-144 to TL-93-167 (inclusive)	1.44	0.18	9.6	0.7
TL-93-105 to TL-93-130 (inclusive)	1.29	0.14	9.9	0.7
TL-93-190 to TL-93-193 (inclusive)	1.31	0.15	9.4	0.7
TL-93-196 to TL-93-197 (inclusive)	1.31	0.15	9.4	0.7
TL-93-171 to TL-93-188 (inclusive)	1.31	0.15	9.4	0.7
TL-93-198 to TL-93-216 (inclusive)	1.37	0.20	9.4	0.6
TL-93-220 to TL-93-241 (inclusive)	1.37	0.20	9.4	0.6
TL-93-258 to TL-93-260 (inclusive)	1.37	0.20	9.4	0.6
TL-93-242 to TL-93-254 (inclusive)	1.43	0.33	9.7	0.7
TL-93-255 to TL-93-257 (inclusive)	1.43	0.33	9.7	0.7
TL-93-261 to TL-93-280 (inclusive)	1.34	0.12	9.6	0.7
TL-93-297	1.34	0.12	9.6	0.7
TL-93-281 to TL-93-296 (inclusive)	1.34	0.12	9.6	0.7
TL-93-311 to TL-93-314 (inclusive)	1.38	0.16	9.6	0.6
TL-93-356	1.38	0.16	9.7	0.6

Both kiln dried lumber and S-GRN lumber were used in this test series. However, all pieces were conditioned to near final conditions approximating 10% moisture content (dry weight basis). In conditioning from the higher moisture levels, differential shrinkage led to some warping or bowing. The pieces were selected to include only relatively straight pieces and to exclude wane, except in a minor degree. The lumber grading rules permit a larger degree of wane than was provided for this study. The species marketing group involved was Spruce-Pine-Fir (SPF) which may include up to six different species. From the source of this material (Quebec), it can be said that three species predominated: balsam fir, spruce and jack pine. The grades ordered were #2 and

better, and stud grade. Stud grade material is cut to length at the mill to specific lengths suitable for wall construction without further trimming. The light framing grades (select structural (SS), No. 1, No. 2, and No. 3) are provided in two-foot length increments. Some of these pieces were used for the top and bottom plates, while others were cut to approximately 8 feet for the studs, paying attention to wane and warp in deciding where the length was to be cut to minimize wastage.

The final lumber conditioning took place at 50% relative humidity and 20°C conditions. At these conditions, all species of wood typically condition to 10% moisture content. Differences in resin, depositions and extractive content lead to some differences between species. In this case, the species are quite similar in this respect. The selected studs were sorted by stiffness and assigned to each wall in the test series so that similar mean and distributional properties were provided to permit comparative analysis.

The flexural stiffness or bending stiffness (EI) of wood studs was measured at FORINTEK using both static and dynamic methods. For the dynamic method, the equipment used was produced by Metriguard. The piece of lumber is set on a point support at one end, and a flat knife edge support at the other (which also includes a load cell). When placed on the supports, the end resting on the load cell is weighed under the control of the data acquisition system. A light tap with either a hammer, or by hand, causes the piece of lumber to vibrate. The signal from the load cell is digitized and the fundamental frequency is calculated from the information. The lumber dimensions (average of four readings on both width and depth), the mass of the piece, and the computed frequency were output to a data file. Since the mass was only measured from one end, and since density variation may lead to one end being lighter than the other, the piece was turned end for end and the test was repeated. The average of the flexural stiffness measures was taken as representing the mean for the piece.

Most pieces were also tested in a universal testing machine on approximately the same span under centre point loading to obtain the load/deflection curve from which the static flexural stiffness could be obtained. This enabled comparison between the flexural stiffness values obtained using the dynamic and static test methods. The results were very similar, and the static measurements are listed in Table B-3.

Table B-3: Flexural Stiffness (EI) of 38x90 mm wood studs.

Test Number	Flexural Stiffness (EI) N•mm ²	
	Average Value	Standard Deviation
TL-93-082 to TL-93-104 (inclusive) TL-93-144 to TL-93-167 (inclusive) TL-93-105 to TL-93-130 (inclusive)	3952213	533885
TL-93-190 to TL-93-193 (inclusive) TL-93-196 to TL-93-197 (inclusive) TL-93-171 to TL-93-188 (inclusive)	3872352	361544
TL-93-198 to TL-93-216 (inclusive) TL-93-220 to TL-93-241 (inclusive) TL-93-258 to TL-93-260 (inclusive)	4044259	727880
TL-93-242 to TL-93-254 (inclusive) TL-93-255 to TL-93-257 (inclusive)	3977602	482797
TL-93-261 to TL-93-280 (inclusive) TL-93-297 TL-93-281 to TL-93-296 (inclusive)	4145340	816947
TL-93-311 to TL-93-314 (inclusive) TL-93-356	3844464	721583

STEEL FRAMING

Weights and dimensions were recorded for all studs and/or resilient furring channels in each wall specimen. The weight per metre for each type varied only slightly, as shown by the statistics in Table B-4.

The stiffness of the steel framing is also relevant to sound transmission through wall assemblies, and data to characterize each type of framing will be assembled. The load/deformation measurement of compressive stiffness provides one useful value, which would apply if the stud is viewed as a spring joining the gypsum board of the wall's two faces. Bending stiffness of the stud (both longitudinal and torsional) is also potentially relevant, for transmission of bending waves from one face to the other. These will be measured for samples of steel studs and resilient channels, and reported in a subsequent IRC/NRCC analysis of the results.

Table B-4: Dimensions and weight of steel framing.

Nominal Type	Mass per Unit Length (kg/m)		Measured Cross Section (mm x mm)
	Average Value	Standard Deviation	
31x92 mm 25 gauge (0.53 mm) steel studs	0.55	0.03	30 x 91
31x92 mm 25 gauge (0.53 mm) steel stud track	0.59	0.06	30 x 91
31x64 mm 25 gauge (0.53 mm) steel studs	0.47	0.01	32 x 65
31x64 mm 25 gauge (0.53 mm) steel stud track	0.42	0.01	32 x 65
31x152 mm 25 gauge (0.53 mm) steel studs	0.78	0.01	30 x 150
31x152 mm 25 gauge (0.53 mm) steel stud track	0.94	0.01	30 x 150
31x41 mm 25 gauge (0.53 mm) steel studs	0.39	0.01	32 x 40
31x41 mm 25 gauge (0.53 mm) steel stud track	0.36	0.04	32 x 40
31x152 mm 18 gauge (1.22 mm) steel studs	2.41	0.01	40 x 150
31x152 mm 18 gauge (1.22 mm) steel stud track	1.97	0.01	30 x 150
31x92 mm 18 gauge (1.22 mm) steel studs	1.79	0.04	40 x 91
31x92 mm 18 gauge (1.22 mm) steel stud track	1.48	0.01	30 x 91
31x92 mm 16 gauge (1.52 mm) steel studs	2.24	0.01	40 x 91
31x92 mm 16 gauge (1.52 mm) steel stud track	1.89	0.01	30 x 91
13 mm 26 gauge (0.45 mm) galvanized steel resilient channel	0.25	0.01	61 x 13

GYPSUM BOARD

The weight of each sheet of gypsum board was recorded. The weights and the total wall area were used to calculate the weight statistics given in Table B-5. The variability in these values was small.

Table B-5: Surface weight for each gypsum board type.

Nominal Type	Surface Weight (kg/m ²)	
	Average Value	Standard Deviation
15.9 mm Type X (A)	11.5	0.1
15.9 mm Type X (B)	10.9	0.1
15.9 mm Type X (C)	11.2	0.3
12.7 mm Type X (A)	10.0	0.2
12.7 mm Type X (B)	9.7	0.2
12.7 mm Type X (C)	8.7	0.1
12.7 mm (A)	7.6	0.2
12.7 mm (B)	8.2	0.1
12.7 mm (B) light weight	7.3	0.1
12.7 mm (C)	8.0	0.2

Dynamic properties of many gypsum board samples have been measured by FORINTEK. All pieces delivered were initially conditioned horizontally on flat pallets. When the gypsum board sheets were required, sheets were machined to test size, and placed in the conditioning laboratory in piles with 3 mm veneer spacers between each sheet to expose all surfaces to the conditioned atmosphere. The gypsum board was held in this way for at least two months even though steady state conditions were attained in a much shorter period of time. The weight of select panels was measured on a daily basis to determine the rate of conditioning. The gypsum board was conditioned using the same environmental conditions (50% relative humidity and 20°C) that were used for the wood studs. The moisture content of the face paper reached 10% relatively quickly. The moisture content of the gypsum (as measured with the same moisture meter which is not calibrated for gypsum board) was found to be approximately 4-5 % higher than for wood under the same environmental conditions. Equilibrium was attained fairly quickly.

The different sizes of gypsum board sheets led to selection of different trimmed widths. The aspect ratio, i.e. ratio of span to width, varied from one subsample to another. However, the influence of this on the results is not believed to be important. The specimen was supported on pipe supports, with approximately a 2.5 cm overhang at both ends. The span was measured to the nearest millimetre. A B&K type 4343 accelerometer was positioned at the centre of the specimen in the centre of the span. The signal was amplified by a B&K type 2644 preamplifier before being directed to a B&K Signal Analyzer type 2034. A B&K type 8202 impact hammer was used to lightly tap each specimen to set it into vibration. The resulting signal in the gypsum board vibration was analyzed to determine the fundamental frequency and the half power points (i.e. frequencies at which the resonance amplitude has dropped by 3 dB with respect to the peak rms spectral level). From this information, the viscoelastic damping was calculated. The transient signal was weighted with an exponential weighting curve which required correction to the computed damping.

The quality factor is defined as,

$$Q = \frac{f_k}{f_u - f_l}$$

where,

f_k = fundamental frequency;

f_u = frequency of the upper half power point and;

f_l = frequency of the lower half power point.

The damping factor is defined as,

$$\zeta_k = \frac{1}{2Q},$$

and the damping coefficient is defined as,

$$\delta_k = 2\pi f_k \zeta_k.$$

If the damping properties were measured using a time window then a correction term must be included. The time window used was exponential and w_l seconds in length. The true measure of the damping coefficient, δ_k , can be expressed in terms of the measured quality factor, Q , by,

$$\delta_k = \frac{\pi f_k}{Q} - \frac{1}{w_l}.$$

Thus, the damping factor expressed in terms of the measured quantities is,

$$\zeta_k = \frac{1}{2\pi} \left[\frac{\pi f_k}{Q} - \frac{1}{w_l} \right].$$

The effective flexural stiffness of the specimen was calculated from the following equation,

$$f_k = \frac{\pi}{2L^2} \left[\frac{gEI}{w_u} \right]^{\frac{1}{2}}$$

where,

- f_k = fundamental frequency (Hz);
- EI = flexural stiffness of the specimen, per unit width of material ($\text{N}\cdot\text{mm}^2/\text{mm}$);
- w_u = specimen weight per unit area (N/m^2);
- L = span (mm); and
- g = gravitational acceleration (m/s^2).

Accounting for acceleration due to gravity, and solving for flexural stiffness, EI , results in,

$$EI = \frac{4f_k^2 L^4 w_u 10^{-9}}{9.8\pi^2}.$$

After testing on the long span, specimens were cut perpendicular to the main axis of the panels as supplied (which was the short axis of the original full sheet of gypsum board) and were trimmed. They were retested to evaluate the flexural stiffness in a perpendicular direction to that obtained previously. In these cases, the shorter specimens

had significantly higher natural frequencies and the method of excitation had to be changed. A light finger tap was used to excite the panels and triggering was set on the output signal from the accelerometer. The time of physical contact between the hammer at impact and the gypsum board was found to be too long causing interference with the free response of the panel.

Table B-6: Flexural Stiffness and Damping Coefficient for each gypsum board type.

Nominal Type	Number of Sample	Orientation	EI (N•mm ² /mm)		Percent Damping (%)	
			Average Value	Standard Deviation	Average Value	Standard Deviation
15.9 mm Type X (A)	-	-	-	-	-	-
15.9 mm Type X (B)	-	-	-	-	-	-
15.9 mm Type X (C)	183	perpendicular	808700	139800	0.91	0.69
	38	parallel	708600	116300	-	-
12.7 mm Type X (A)	82	perpendicular	385000	98000	-	-
	25	parallel	434800	64700	-	-
12.7 mm Type X (B)	3	perpendicular	372400	13100	0.68	0.08
12.7 mm Type X (C)	-	-	-	-	-	-
12.7 mm (A)	12	perpendicular	316600	76400	0.90	0.22
	24	parallel	262600	74900	-	-
12.7 mm (B)	20	perpendicular	309700	89900	1.15	0.76
	17	parallel	319500	30600	-	-
12.7 mm (B) light weight	11	perpendicular	234900	5800	0.46	0.08
	21	parallel	312000	24000	-	-
12.7 mm (C)	-	-	-	-	-	-

Orientation: Perpendicular - span tested was perpendicular to the long axis of a sheet of gypsum board.

Parallel - span tested was parallel to the long axis of a sheet of gypsum board.

SUMMARY

This Appendix presents an overview of preliminary results from an initial systematic study including specimen details that deviate significantly from normal practice. The specimens were chosen to examine basic dependence of the sound transmission on material properties and construction details. The work focused on the effect of four main specimen characteristics:

- properties of cavity absorption (density, airflow resistance);
- amount and location of absorptive material;
- spacing and type of framing;
- how gypsum board is attached to framing.

The results are discussed below under these four main topic headings. Note that we have not examined all issues important for the systematic study; other aspects (such as dependence on type and thickness of gypsum board) were examined in the course of the main series.

This first set of measurements was intended both to establish the basis for a model to calculate sound transmission through similar constructions, and to establish a technical basis for selecting specimen details for the subsequent study of constructions with standard details. The results clearly illustrate several important issues:

1. Thickness of cavity absorption clearly plays a significant role. The highest STC values will be obtained with absorption essentially filling the cavity, but it would be useful to establish performance equivalences for various thicknesses of materials with different flow resistance.
2. Screw spacing has a significant effect even with steel studs. The specific screw spacings for all walls in the main series with each stud and resilient channel case, for both single and double layers of gypsum board, must provide the basis to evaluate the full range of common cases of stud and screw spacing.
3. Orientation of the gypsum board affects the results. The panel layout, for both single and double layers of gypsum board with each stud and resilient channel case, must be evaluated.

The detailed sound transmission results are presented and discussed in following sections. A summary of main trends is given in the final section.

PROPERTIES OF CAVITY ABSORPTION

Some researchers have argued that sound transmission does not depend on density of the cavity absorption. On the other hand, some studies have shown that different products do give different sound transmission performance. One concern of this study was to establish whether any obvious physical characteristic of the absorptive material can be used to gauge its effectiveness.

To focus on the effect of absorption properties, we used a specimen with rather light and flexible panels, to avoid panel resonances in the frequency range of concern. The specimen had surfaces of 3 mm thick LEXAN plastic, with an airspace between the two surfaces which could be partially filled with absorptive material. The LEXAN surfaces were supported in a manner chosen to minimize structural connection between the two faces. Wires were used to hold the absorptive material in place, preventing contact with the LEXAN surfaces.

Fig. 1: Sound transmission loss with 100 mm of different materials in the 150 mm cavity between two sheets of 3 mm LEXAN plastic. Specimens are coded as follows: GFB is glass fibre batt, GFR is glass fibre rigid board, MFB is mineral fibre batt.

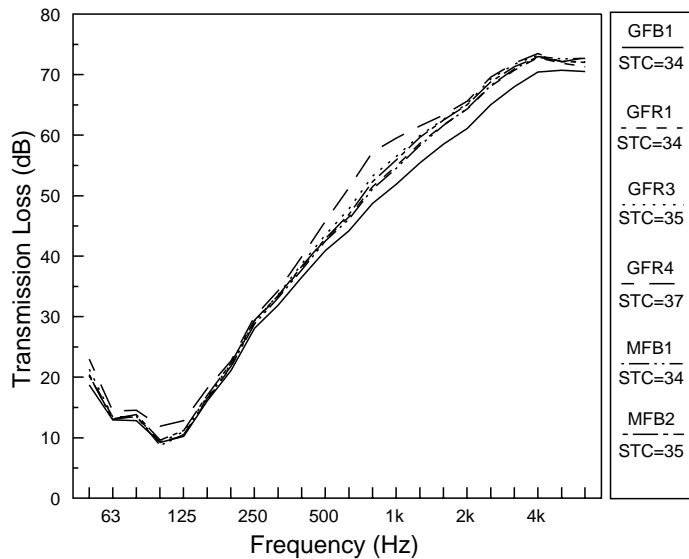

Practical installation problems prevented the use of spray-on or blown-in insulation, and foam insulation was rejected because other studies have shown its acoustical transmission to be slightly different from that for fibrous insulations. Figure 1 shows the range of sound transmission results with a variety of mineral fibre and glass fibre batt and board materials.

The most obvious feature is the similarity of results for different materials, but some materials provided consistently higher performance.

Figs. 2(a) and 2(b): Sound transmission loss in the 1 kHz band versus density and airflow resistance of the materials. Specimens are coded as follows: GFB is glass fibre batt, GFR is glass fibre rigid board, MFB is mineral fibre batt.

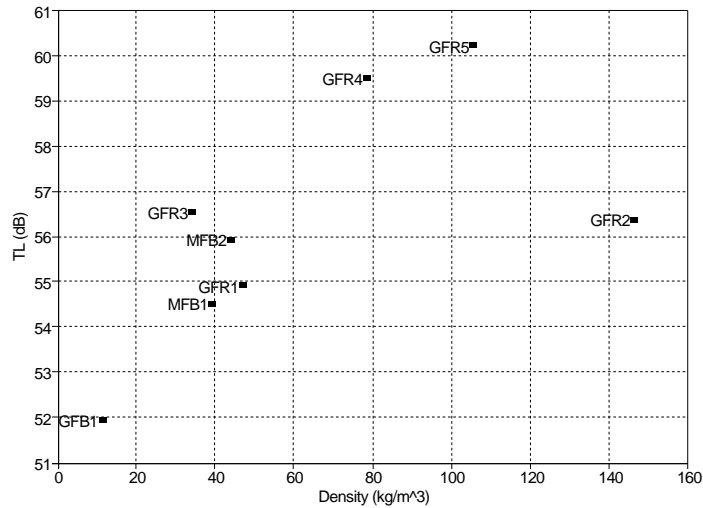
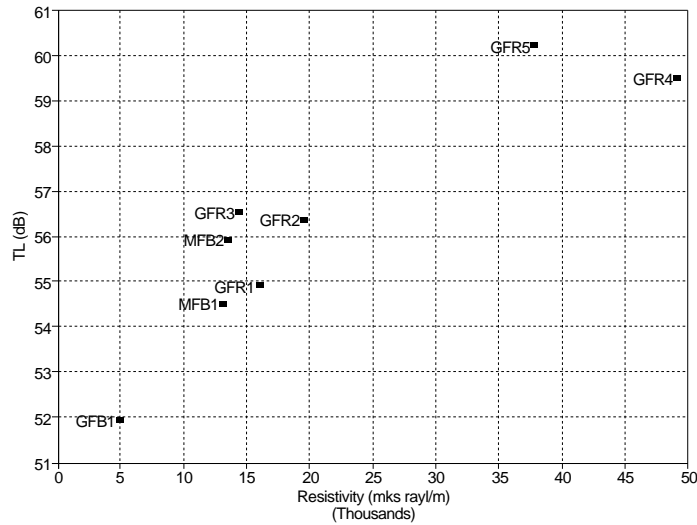

These differences were most obvious for the frequency range around 1 kHz. Figures 2(a) and 2(b) show the 1 kHz sound transmission data versus the materials' density and airflow resistance, respectively. When sound transmission loss is plotted against airflow resistance, there seems to be a clear trend - an increase with increasing airflow resistance. When plotted against density, the trend is questionable.

Figs. 3(a) and 3(b): Sound transmission class (STC) versus density and airflow resistance of the materials. Specimens are coded as follows: GFB is glass fibre batt, GFR is glass fibre rigid board, MFB is mineral fibre batt.

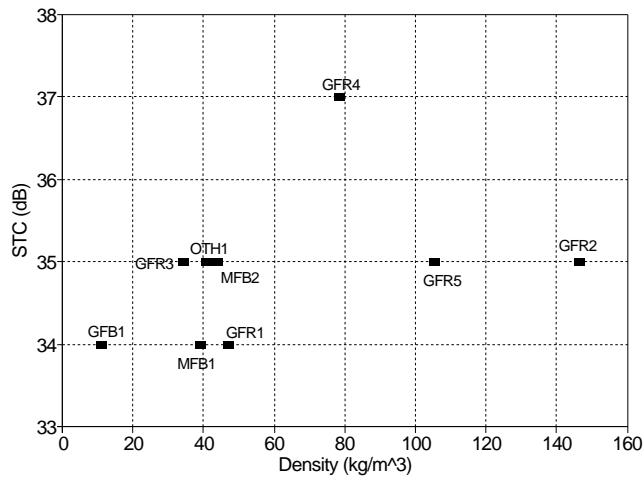
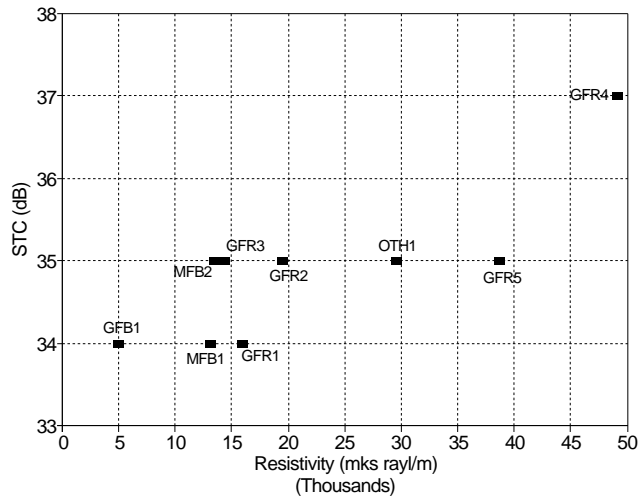

There is some similarity because density and flow resistance were quite closely correlated for most samples used in this study. For a given fibre size, both density and airflow resistance increase as the fibres are packed more tightly together. The best test of the principle is given by the results for specimens GFR2; although it has the highest density, its acoustical performance is in the middle of the pack, like its airflow resistance. Overall, the results support the theory that airflow resistance is the significant physical variable.

For sound transmission class (STC) results, the effect is much smaller, but the trend is basically the same. The STC for these specimens is determined by the low frequency bands, especially 125 Hz, because of the shape of the STC contour and the rules for fitting it to the data. Around 125 Hz the effect of absorption type is reduced, but essentially

the same trend is observed: the material with highest airflow resistance gives the highest STC.

Amount and Location of Absorptive Material

The amount of absorption in the cavity has a significant effect on the sound transmission - the greater the fraction of the cavity filled with absorption, the higher the sound transmission loss.

The location of the absorption appears to have a small secondary effect. That will require further study to clearly establish the best locations, because the most effective installation may also depend on contact with the gypsum board. Those aspects will be pursued further in the main series with more conventional wall constructions.

Figure 4 shows sound transmission loss for a wall with negligible structural connection between two LEXAN surfaces 205 mm apart, when an absorptive layer of 50 mm, 100 mm or 200 mm thickness is added to the cavity. The absorptive material used in this case was labeled GFR1 in previous figures, and has air flow resistance similar to the best batt materials. The sound transmission loss continued to increase with increasing thickness of the absorptive material. With the cavity half-filled with absorptive material, the sound transmission loss was about 5 dB less than that obtained by filling the cavity completely.

Fig. 4: Sound transmission loss with different thickness of absorptive material in the 205 mm cavity between two sheets of 3 mm LEXAN plastic. Specimens had 0, 50, 100, 200 mm thick layers, respectively, of glass fibre board (type GFR1). The absorptive material was held in place by wires to prevent contact with the LEXAN surfaces.

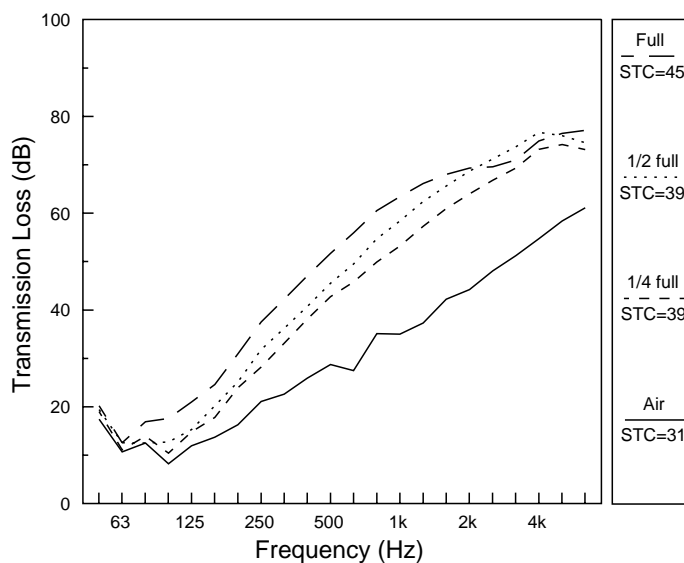

The second case studied had an increasing fraction of the cavity blocked by absorption. The added absorption filled the (bottom) 1/4, 1/2, ... of the opening with glass fibre batt material. Again, the amount of absorption in the cavity had a significant effect on the sound transmission - the greater the fraction of the cavity filled with absorption, the higher the sound transmission loss.

In this case, the sound transmission loss approached the limiting (100% coverage) case more slowly; for example, leaving the top quarter of the cavity empty reduced the transmission loss by more than 5 dB at the higher frequencies (although the STC was reduced only by 2). Thus, it seems desirable to have absorptive material nearly fill the cavity from top to bottom and side to side.

Fig. 5: Sound transmission loss with different amounts of absorptive material in the 205 mm cavity between two sheets of 3 mm LEXAN plastic. The added absorption covered the (bottom) 1/4, 1/2, 3/4, 7/8, 8/8 of the opening, respectively, with glass fibre batt (type GFB1) material 200 mm thick (two layers of 100 mm). The absorptive material was held in place by wires to prevent contact with the LEXAN surfaces.

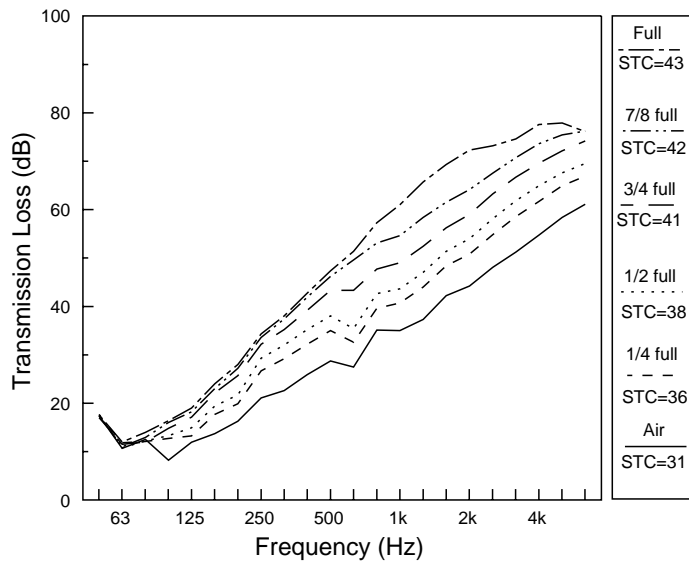

Note that even the “full” case shown in Fig. 5 has lower transmission loss than the best case in Fig. 4, because the material (GFB1) has lower air flow resistance.

Spacing and Type of Framing

Sound transmission through practical walls depends on how the gypsum board is attached to the supporting studs, and on the stud system itself. More detailed investigation of the mechanisms will continue, but the preliminary study has established the general trends. The sound transmission depends on at least three main variables:

- type of studs (wood or lightweight steel);
- spacing between studs;
- spacing between screws.

Fig. 6 shows sound transmission through six walls with gypsum board on each face and studs spaced 610 mm apart. The three walls with wood studs have lower transmission loss than the three with steel studs. The differences within each group of three walls are due to spacing of the screws attaching the gypsum board to the studs.

Fig. 6: Sound transmission loss through walls with 15.9 mm Type-X gypsum board on each face of the studs. Three walls have 38 x 89 mm wood studs, the other three have 90 mm lightweight steel studs; all studs are spaced at 610 mm on center and have glass fibre batts filling the inter-stud cavities. The legend indicates the type of stud, and the spacing between the screws fastening the gypsum board to the studs.

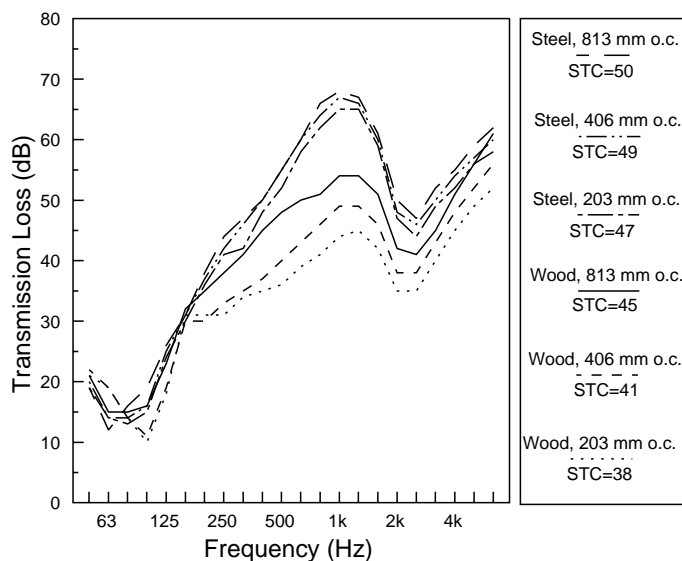

At frequencies above 160 Hz, both stud types exhibit higher transmission loss if the screws are farther apart. For the three walls with steel studs, the transmission loss is higher and the effect of screw spacing much less, presumably because transmission through the studs is less important with steel studs.

At frequencies below 160 Hz, each of the curves exhibits a minimum; the frequency at which this occurs depends on the stud type and screw spacing. It is worth discussing because this dip tends to limit the STC

rating for these constructions. The resonance shifts to higher frequency (and the STC is reduced more), the more rigidly the stud and screws constrain the gypsum board. The resonance is at its highest frequency for wood studs with the screws close together, and at its lowest frequency for the more flexible steel studs with the largest screw spacing.

The sound transmission (especially the low frequency resonance) is also affected by stud spacing, as shown in Fig. 7 for four walls with wood studs at different separations.

Fig. 7: Sound transmission loss through walls with 15.9 mm Type-X gypsum board on each face of 38 x 89 mm wood studs. In all cases, the gypsum board is attached to the studs by screws spaced 406 mm on center. The legend indicates the spacing between the studs in each case.

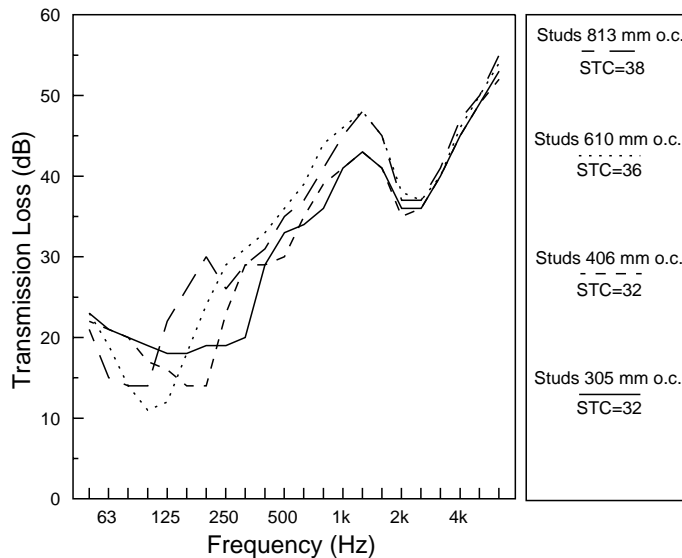

The frequency at which the minimum occurs depends strongly on the stud spacing - the smaller the spacing, the higher the frequency at which the dip occurs. Although the effect is stronger with wood studs, dependence on stud spacing also affects low frequency performance with steel studs.

This low frequency dip controls the STC for most steel stud walls; understanding and reducing this effect would provide higher STC for all such constructions.

Much weaker dips are observed in the sound transmission data with gypsum board on only one side of the wall; presumably the studs divide the gypsum board panel into subpanels whose modal resonances are at higher frequencies for smaller subpanels, i.e. for smaller stud-spacing. But transmission from one surface to the other through the studs is also apparently part of the cause of the strong dips in the transmission loss.

How Gypsum Board is Attached

As discussed previously, increasing the spacing between screws significantly increases the sound transmission loss. Other more extreme changes in how the drywall is attached to the studs can give comparable effects. The goal is to find methods that will provide acceptable noise control with conventional wood stud construction.

Figure 8 shows the improvement in sound transmission loss when the gypsum board is attached to the studs with a variety of connecting elements: pads at the screw points (both hard and soft), and resilient channels (both parallel the studs and at right angles). These methods of attachment obviously improve the sound transmission loss, presumably by reducing vibration transfer through the studs from one surface to the other.

Fig. 8: Sound transmission loss through walls with 15.9 mm Type-X gypsum board on each face of 38 x 89 mm wood studs. In all cases, the studs were spaced 406 mm on center, the inter-stud cavities were filled with glass fibre batts, and gypsum board was attached by screws spaced 406 mm on center. The wood and rubber pads had surfaces 40 x 40 mm, and were positioned with double-sided tape to hold them in place; screws were then driven through the gypsum board and pads, into the studs. The resilient channels (RC in the legend) were attached to the studs with screws at 406 mm centers.

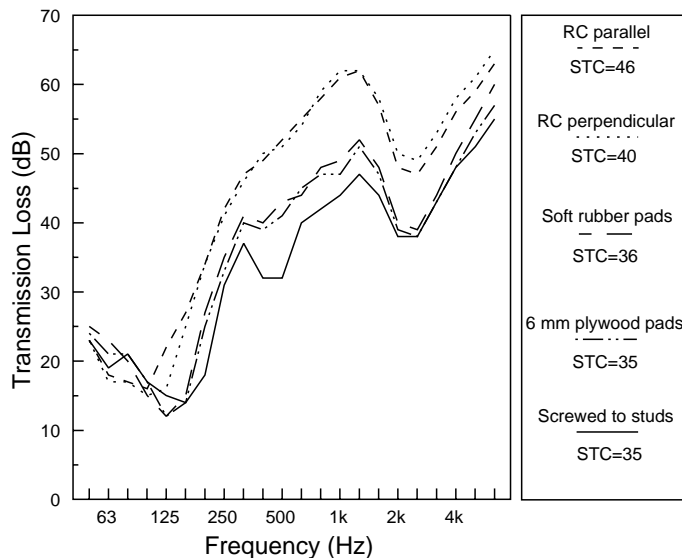

The greatest improvement was with the resilient channels, which gave sound transmission results comparable to those with steel studs spaced 610 mm apart. Aligning the resilient channels parallel to the studs (rather than the conventional horizontal alignment) gave further

improvement at the especially important low frequencies. These findings will be investigated further, in the hope of developing an improved attachment method.

Orientation of the gypsum board also has some effect on the results, especially on the simple wood studs. Figure 9 presents results for walls with wood or steel studs spaced 610 mm on center, with the gypsum board applied either vertically (long dimension of the sheet vertical) or horizontally (long dimension of the sheet horizontal).

With steel studs there was only a small effect due to gypsum board orientation - a slight increase for horizontal drywall, at frequencies above 160 Hz. With wood studs, the horizontal orientation was slightly superior at high frequencies, but at lower frequencies there were large changes when the drywall was attached vertically. This effect is puzzling, and will be investigated further.

Fig. 9: Sound transmission loss through walls with 15.9 mm Type-X gypsum board on each face of studs (38 x 89 mm wood studs, or 90 mm steel studs). In all cases, the studs were spaced 610 mm on center, the inter-stud cavities were filled with glass fibre batts, and gypsum board was attached by screws spaced 406 mm on center. "Horizontal" in the legend indicates gypsum board installed with its long dimension horizontal. "Vertical" in the legend indicates gypsum board installed with its long dimension vertical.

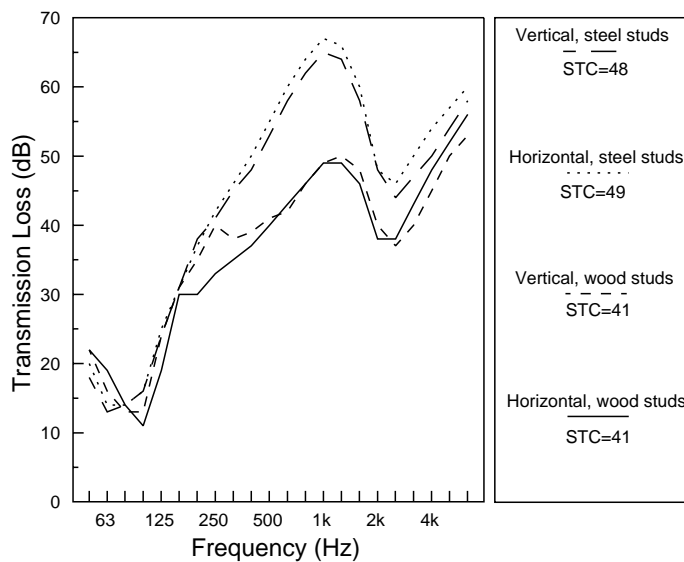

Basic Trends and Issues for Further Study:

Several basic trends were identified:

- Effectiveness of absorptive material increased with increasing air flow resistance, but differences among products were not large, especially at the low frequencies which are important for the STC rating.
- Increasing the fraction of the cavity filled with absorptive material improved the sound transmission loss steadily, in a partition with negligible structural connection between the surfaces. With a half-filled cavity the STC was 6 dB lower than with a full cavity.
- Structural connections greatly reduce the sound transmission loss; this effect is less for lightweight steel studs than for wood studs, and appears to involve different mechanisms in the frequency ranges below and above about 200 Hz.
- At the higher frequencies, the effective transmission loss is lowered if screw-spacing or stud-spacing is reduced, but agreement with existing prediction models is qualitative at best.
- At lower frequencies, the strong minima observed in the transmission loss clearly depend on stud spacing. These are tentatively ascribed to the modal response of the stiffened panels, coupled by vibration transmission through the studs.
- Several attachment details intended to reduce coupling between the studs and the gypsum board were tested, but none offered a large improvement relative to conventional constructions such as non-loadbearing steel studs or wood studs with resilient channels.

Several issues were not addressed in this part of the study because they can be examined more appropriately as part of the main series of tests. These include:

- The change in sound transmission due to thickness, weight, or stiffness of gypsum board are expected to depend on the supporting structure. A range of gypsum board products were therefore be tested for several common wall constructions.
- Contact between absorptive material and the gypsum board may alter damping or effective weight of the gypsum board panels. This was tested with spray-on materials, and with insulation pressed against one or both of the surfaces.
- If absorptive material is compressed between the gypsum board surfaces, it can transmit vibration directly from one surface to the other. This was tested to establish practical limits of compressibility and stiffness in the main series, but needs further study.